

INSTALLATION CHANNEL

035-0253G



Progetto / Tipo

Appunti

Quantità / Data

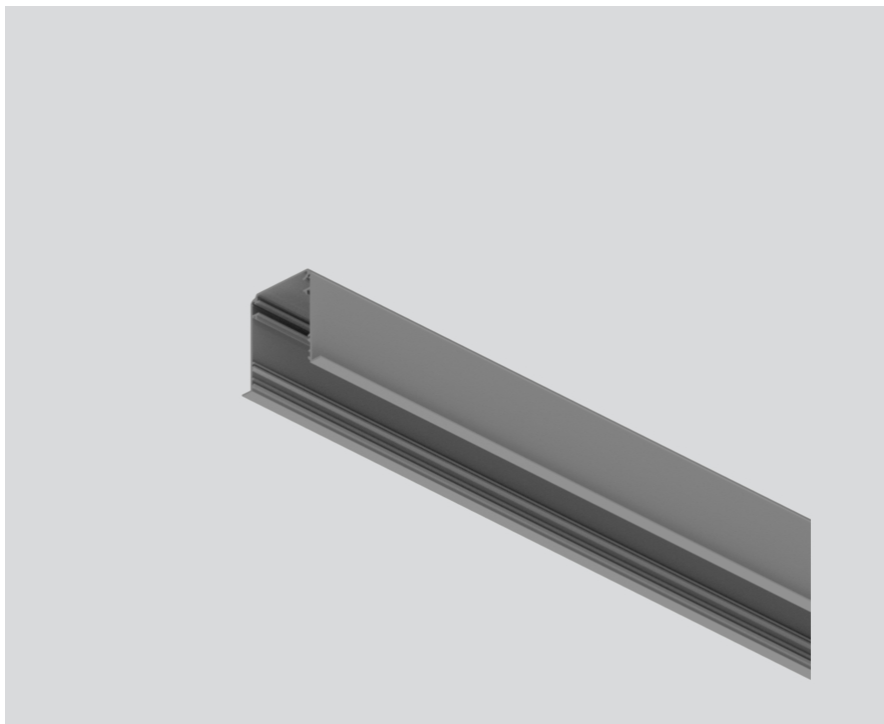

Generale

2344 mm

alluminio bianco

Dati fisici

length 2344 mm

width 77 mm

altezza 76 mm

0.5 kg

A sospensione