



## Description

**EN** Round or square, slim rectangular lamp made of aluminium;  $\pm 10^\circ$  rotatable; surface black or natural anodised; plug and play electrical connector system for toolless mounting; beam angle  $132^\circ$ ; passively cooled high-power LED system; available in the light colours 3000K and 4000K; min. 90% of the luminous flux after 50000 hours; colour rendering  $\text{CRI} \geq 95$  ( $\text{R}_9 \geq 90$ ); 350mA converter plug and play; converter separately available; degree of protection IP20; PC I / PC II (power supply) or PC III (light insets); optionally non-dimmable or DALI-2 control

**IT** Profilo faro rotondo o quadrato e sottile in alluminio; girevole  $\pm 10^\circ$ ; superficie nera o anodizzata naturale; montaggio senza attrezzi tramite connettore con innesto rapido a baionetta; angolo del fascio di  $132^\circ$ ; sistema LED High Power a raffreddamento passivo; disponibile in temperatura di colore 3000K e 4000K; min. 90% di flusso luminoso rimanente dopo 50000h di durata; reso cromatico  $\text{CRI} \geq 95$  ( $\text{R}_9 \geq 90$ ); convertitore da 350mA premontato e pronto all'uso; convertitore da ordinare separatamente; protezione IP20; classe isolamento I / II (alimentazione) o classe isolamento III (unità luce); a scelta non dimmerabile o comandi con DALI-2

**PICO SUPPORT** round/square  
standing

## Quickinfo

3000 K, 4000 K  
 $\text{CRI} \geq 95$  ( $\text{R}_9 \geq 90$ )  
 L90 @ 50000 h  
 L 290 up to 249 lm  
 L 580 up to 498 lm  
 L 880 up to 747 lm  
 L 1180 up to 996 lm  
 non DIM, DALI-2

## Types

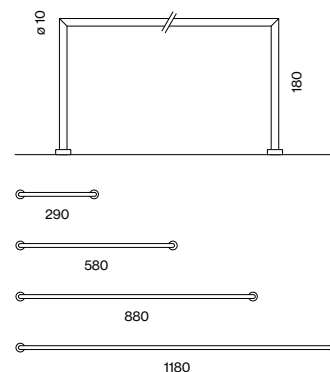

## Colours



## Light distribution



132°

### Order options

| COLOUR TEMPERATURE |              | ☼☼ |
|--------------------|--------------|----|
| 3000K              | CRI≥95 70lm* | 5  |
| 4000K              | CRI≥95 83lm* | 6  |

\*per LED | CRI≥95 (R9≥90) | 350mA | 53°C

| MATERIAL COLOUR    |  | ■ |
|--------------------|--|---|
| anodised aluminium |  | 6 |
| anodised black     |  | 8 |



### PICO SUPPORT round standing

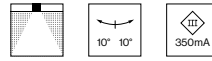

| SYSTEM POWER / VOLTAGE | NO. OF LEDS | L (mm) | ORDER CODE                                      |
|------------------------|-------------|--------|---|
| 3×1.1W / 10V           | 3           | 290    | 007-4201::1 <input checked="" type="checkbox"/> |
| 6×1.1W / 19V           | 6           | 580    | 007-4202::1 <input checked="" type="checkbox"/> |
| 9×1.1W / 29V           | 9           | 880    | 007-4203::1 <input checked="" type="checkbox"/> |
| 12×1.1W / 38V          | 12          | 1180   | 007-4204::1 <input checked="" type="checkbox"/> |

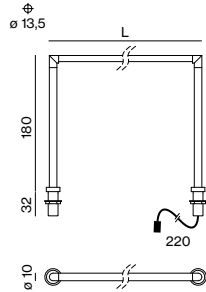

### PICO SUPPORT square standing

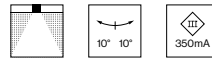

| SYSTEM POWER / VOLTAGE | NO. OF LEDS | L (mm) | ORDER CODE                                      |
|------------------------|-------------|--------|---|
| 3×1.1W / 10V           | 3           | 290    | 007-4211::1 <input checked="" type="checkbox"/> |
| 6×1.1W / 19V           | 6           | 580    | 007-4212::1 <input checked="" type="checkbox"/> |
| 9×1.1W / 29V           | 9           | 880    | 007-4213::1 <input checked="" type="checkbox"/> |
| 12×1.1W / 38V          | 12          | 1180   | 007-4214::1 <input checked="" type="checkbox"/> |

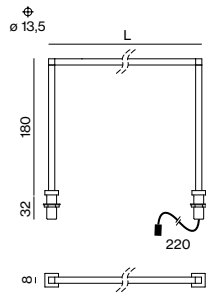

### ILLUMINANCE EXAMPLE (E<sub>max</sub> in lux)

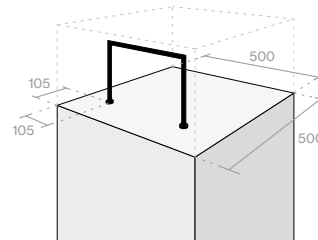

| BEAM ANGLE | COLOUR TEMP. | L 290mm<br>1x(3x1.1W) |
|------------|--------------|-----------------------|
| 132°       | 3000K        | 1626                  |

reflection factors 0.2/0.5/0.7  
maintenance factor 0.8

### LIGHT DISTRIBUTION

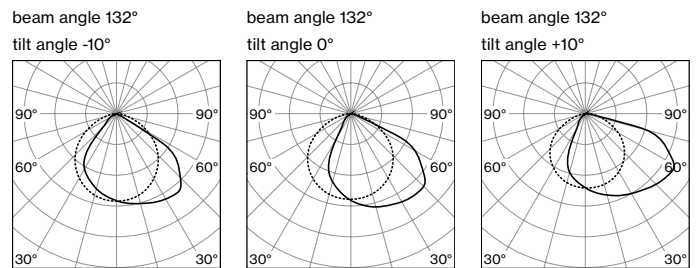

### Electrical accessories

**CONVERTER** supply 220-240V AC, 350 mA, 50-60 Hz  
incl. power cable 2m + connection cable with plug 1m

| TYPE                | FIXTURES    | CABLE (m) | L-W-H (mm) | ORDER CODE  |
|---------------------|-------------|-----------|------------|-------------|
| 7W / 3-14V non DIM  | ☐ PC II 1-2 | max. 12   | 68-35-21   | 007-1951160 |
| 30W / 2-50V non DIM | ⊕ PC I 1-5  | max. 18   | 187-30-21  | 007-1951560 |
| 18W / 10-54V DALI-2 | ☐ PC II 2-5 | max. 18   | 147-44-30  | 007-1951580 |

### SPLITTER SERIAL, AWG22

| TYPE                         | INPUT / OUTPUT    | L-W-H (mm) | ORDER CODE  |
|------------------------------|-------------------|------------|-------------|
| splitter 350mA + cable 500mm | 1×socket / 9×plug | 85-50-10   | 007-1959110 |

### EXTENSION CABLE

| TYPE            | INPUT / OUTPUT    | L (mm) | ORDER CODE  |
|-----------------|-------------------|--------|-------------|
| extension cable | 1×socket / 1×plug | 1000   | 007-1961260 |
| extension cable | 1×socket / 1×plug | 2000   | 007-1961460 |
| extension cable | 1×socket / 1×plug | 4000   | 007-1961660 |