



VARO 110 S

track

EN Track light made of die-cast aluminium; surface powder coated; spotlight head 355° rotatable and 90° tiltable; integrated converter in the plastic adapter; high quality reflector with spherical facet finish; precise radiation characteristics with different beam angles; installed and exchanged without tools; optical attachments as accessories; optical attachments can be combined; COB (Chip on Board) technology for maximum efficiency; variants with > 120 lm/W available; no multiple shadows; energy-efficient LEDs with very good colour rendering; adapter for toolless insertion or movement on a variety of 3-phase power tracks

FI Faretto da binario elettrificato in alluminio pressofuso; verniciatura a polvere; testata girevole 355° e orient. 90°; converter integrato nell'adattatore in plastica; riflettore di alta qualità con ottica a sfaccettature sferiche; curva fotometrica precisa con diversi angoli di emissione; montaggio e smontaggio senza utensili; unità ottiche come accessori; accessori ottici combinabili tra loro; con tecnologia COB (Chip on Board) per la massima efficienza; disponibili varianti con > 120 lm/W; assenza di ombre multiple; LED ad efficienza energetica con elevata resa cromatica; adattatore per installazione senza utensili o scorrimento in vari binari trifase

Quickinfo

3000K, 3500K, 4000K
CRI ≥ 90, 3 SDCM
up to 139 lm/W
L85/50 000h
non DIM, DALI-2

Type

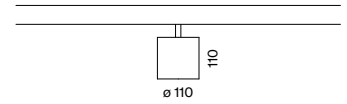

Colours



Light distributions



compatible with
MOVE IT PRO



up to 139 lm/W
(high efficiency)

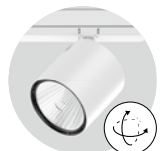

355° rotatable
90° tiltable

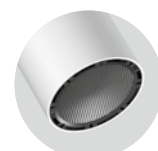

optical
accessories



optical accessories
can be combined

Order options

COLOUR TEMPERATURE

3000K	0
3500K	2
4000K	1

CONTROL

non DIM	1
DALI-2	3

MATERIAL COLOUR

○ traffic white RAL 9016	7
● jet black RAL 9005	8

BEAM ANGLE

spot 17°	S
medium 28°	M
flood 38°	F
wide flood 65°	W

Options on request

LUMINOUS FLUX

>5000lm	
---------	--

CONTROL

Casambi	
---------	--

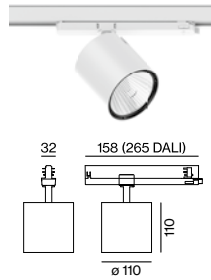

VARO 110 S track



HIGH EFFICIENCY

SYSTEM POWER	COLOUR TEMP.	LUMINOUS FLUX	ORDER CODE
23.4W	3000K	3200lm	180-6530
	3500K	3240lm	
	4000K	3250lm	
36W	3000K	4480lm	180-6531
	3500K	4540lm	
	4000K	4550lm	

Optical accessories

LENSES AND HONEYCOUMB LOUVER

TYPE	ØH (mm)	ORDER CODE
oval lens	106-9	080-6502210
wide flood lens	106-9	080-6502110W
honeycomb louver	106-9	080-6501118

SNOOT

TYPE	ØH (mm)	ORDER CODE
short	97-23	080-6503118
medium	97-38	080-6503218
angle	97-38	080-6503318

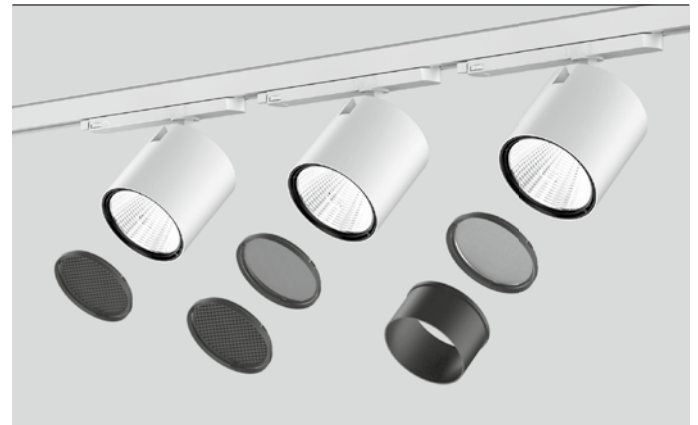

possibility to combine different optical accessories (max. 2 pieces)



Types

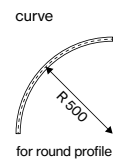
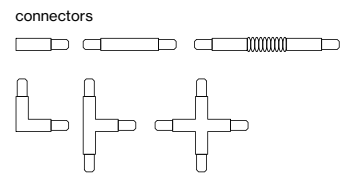
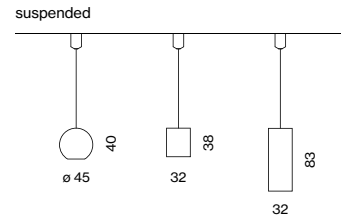
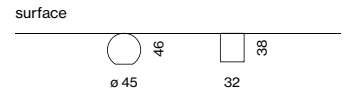
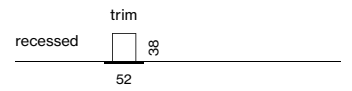

Colours



TRACK 3-phase
recessed/surface/suspended



curve connector



optimised adapter integration

TRACK recessed

Order options

CONTROL

non DIM

DALI-2

MATERIAL COLOUR

- pure white RAL 9010 7
- jet black RAL 9005 8

Pole options

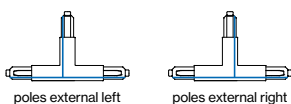
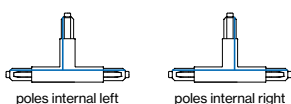

TRACK 3-phase/3-phase + DALI-2-bus



TRACK 240V-16A

L (mm)	ORDER CODE
2000	186-012213
3000	186-012313
4000	186-012413

end cap 186-022011

end feed left 186-022313
 end feed right 186-022413
 middle feed 186-021323

CONNECTORS 240V-16A

TYPE **ORDER CODE**
 linear connector 186-021113

I-connector 186-022123

L-connector right 186-022133
 L-connector left 186-022233

T-connector right (poles internal) 186-022143
 T-connector left (poles internal) 186-022243
 T-connector right (poles external) 186-022173
 T-connector left (poles external) 186-022273

X-connector 186-022153

MOUNTING ACCESSORIES

TYPE **ORDER CODE**
 clip 186-0225110
 cutting tool 186-0219110

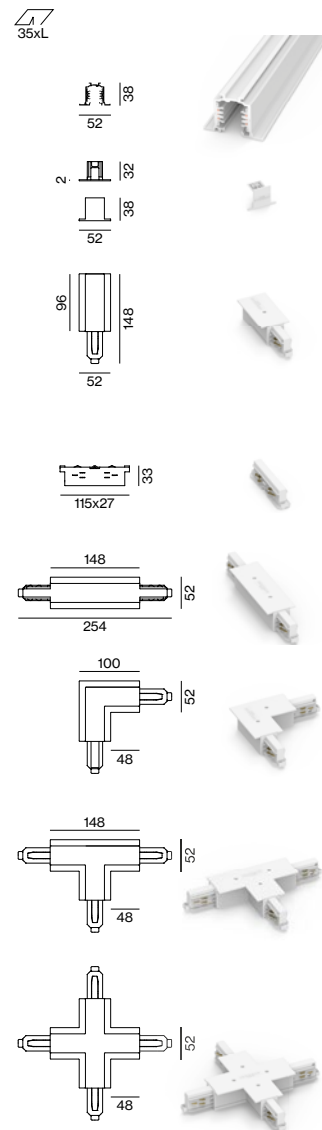

TRACK

surface/suspended

Order options

CONTROL

non DIM
 DALI-2

MATERIAL COLOUR

- pure white RAL 9010 7
- grey 6
- jet black RAL 9005 8

Pole options

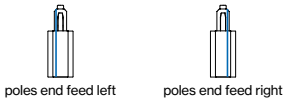
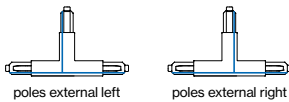
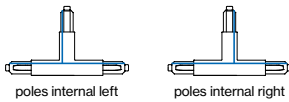

TRACK 3-phase/3-phase + DALI-2-bus



TRACK 240V-16A

L (mm)	ORDER CODE
1000	186-011123
2000	186-011223
3000	186-011323
4000	186-011423

end cap 186-021011

end feed left 186-021313
 end feed right 186-021413
 middle feed* 186-021323

*only available in white and black

CONNECTORS 240V-16A

TYPE ORDER CODE
 linear connector 186-021113

I-connector 186-021123

L-connector right 186-021133
 L-connector left 186-021233

T-connector right (poles internal) 186-021143
 T-connector left (poles internal) 186-021243
 T-connector right (poles external) 186-021173
 T-connector left (poles external) 186-021273

X-connector 186-021153

adjustable corner connector 186-021163

MOUNTING ACCESSORIES

TYPE ORDER CODE
 ceiling clip 186-021511

pendant clip cable 186-021521
 pendant clip rod 186-021541

joiner piece cable 186-021531
 joiner piece rod 186-021551

cutting tool 186-0219110

SUSPENSION KIT

TYPE ORDER CODE
 pendant 1000 186-021611

cable 1500 186-0217110
 cable 3000 186-0217210
 cable 5000 186-0217310

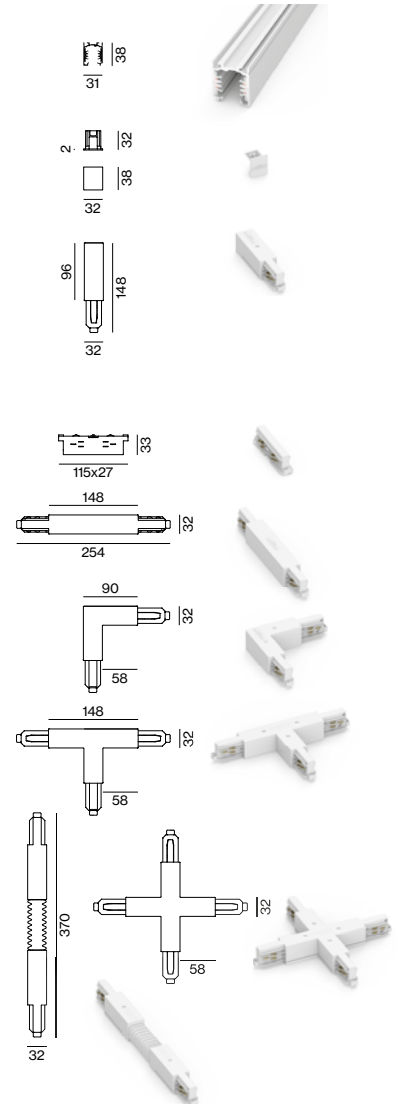

TRACK high

surface/suspended

Order options

CONTROL

non DIM

DALI-2

MATERIAL COLOUR

○ pure white RAL 9010 7

● jet black RAL 9005 8

Options on request

LIGHT OPTIC COVER

inset indirect

Pole options

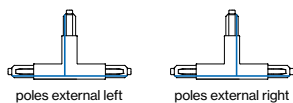
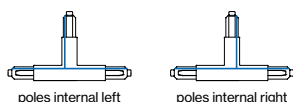

TRACK high 3-phase/3-phase + DALI-2-bus



TRACK 240V-16A

L (mm)	ORDER CODE
1000	186-016113
2000	186-016213
3000	186-016313
4000	186-016413

end cap 186-026011

end feed left 186-026313

end feed right 186-026413

middle feed 186-021323

CONNECTORS 240V-16A

TYPE **ORDER CODE**
linear connector 186-026113

I-connector 186-026123

L-connector right 186-026133

L-connector left 186-026233

T-connector right (poles internal) 186-026143

T-connector left (poles internal) 186-026243

T-connector right (poles external) 186-026173

T-connector left (poles external) 186-026273

X-connector 186-026153

MOUNTING ACCESSORIES

TYPE **ORDER CODE**
pendant clip cable 186-0265210
pendant sheet metal clip 186-0215220
pendant clip rod 186-0265410

joiner piece cable 186-0265310

joiner piece rod 186-0265510

cutting tool 186-0219110

SUSPENSION KIT

TYPE **ORDER CODE**
pendant 1000 186-0216110

cable 1500 186-0217110

cable 3000 186-0217210

cable 5000 186-0217310

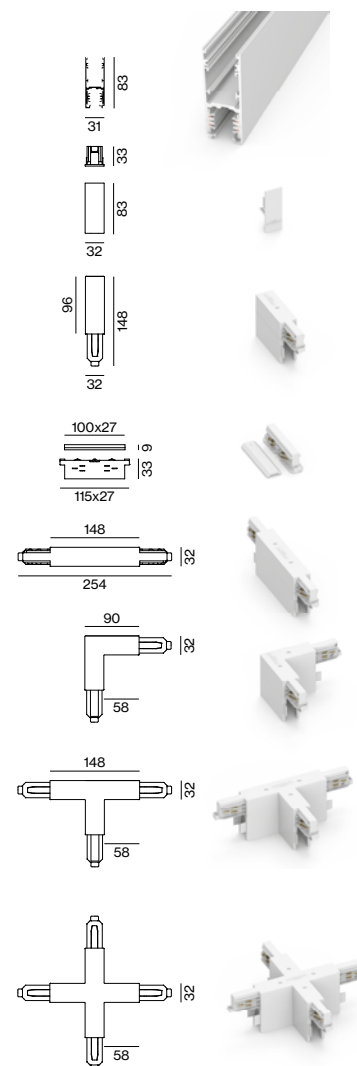

TRACK round surface/suspended

Order options

CONTROL

non DIM
DALI-2

MATERIAL COLOUR

○ pure white RAL 9010 7
● jet black RAL 9005 8

Pole options

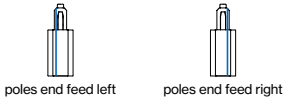
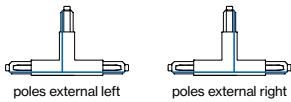
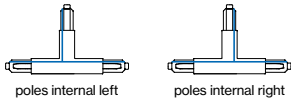

TRACK round 3-phase/3-phase + DALI-2-bus



TRACK 240V-16A

L (mm)	ORDER CODE
1000	186-015113
2000	186-015213
3000	186-015313
4000	186-015413

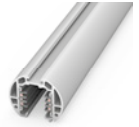

TRACK CURVE 240V-16A

TYPE	ORDER CODE
R 500 90° left	186-015853
R 500 90° right	186-015863

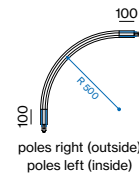

end cap 186-025011



end feed left 186-025313
end feed right 186-025413
middle feed 186-021323

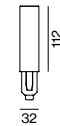

CONNECTORS 240V-16A

linear connector 186-021113



L-connector right (external) 186-025133
L-connector left (internal) 186-025233

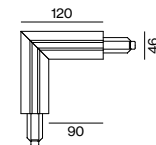

T-connector left (poles external) 186-025243
T-connector right (poles external) 186-025143
T-connector right (poles internal) 186-025273
T-connector left (poles internal) 186-025173

X-connector 186-025153

MOUNTING ACCESSORIES

pendant clip cable 186-025521
pendant clip rod 186-025541

joiner piece cable 186-025531
joiner piece rod 186-025551

cutting tool 186-0279110

SUSPENSION KIT

pendant 1000 186-021611

cable 1500 186-0217110
cable 3000 186-0217210
cable 5000 186-0217310