

# CONCRETE INSTALLATION HOUSING

042-7195410



Progetto / Tipo

Appunti

Quantità / Data

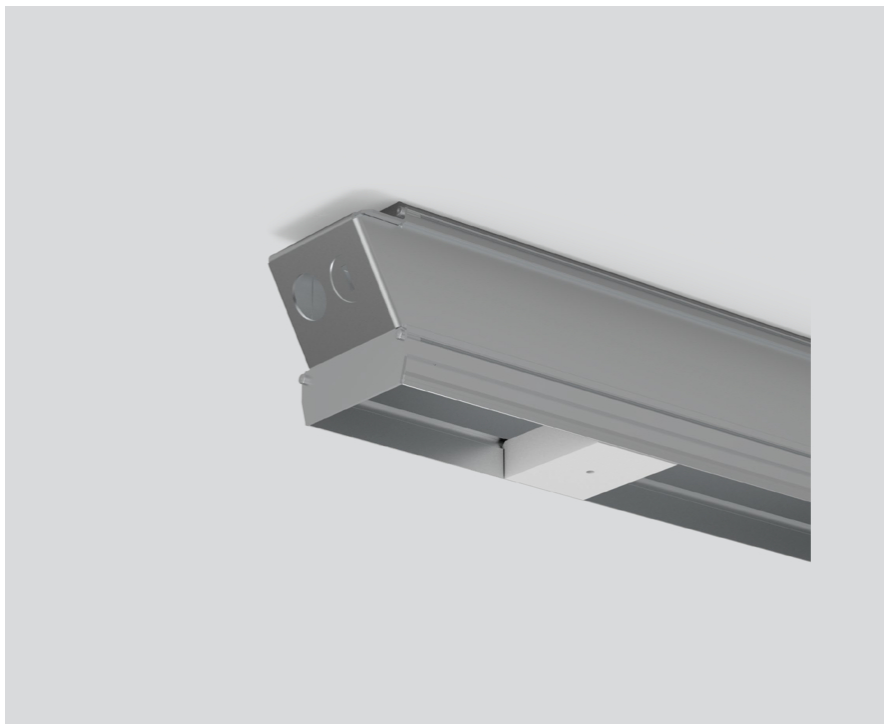

## Generale

2038 mm

## Dati fisici

length 2038 mm

width 57 mm

height 87 mm

incasso con bordo

## Istruzioni di montaggio



## Disegno prodotto

