

TASK angular

suspended

^{EN} Rectangular suspended luminaire, consisting of single L-shaped or rectangular elements; Luminaire housing made of aluminium – rounded edges; ultra low-profile design (only 15 mm); surface powder coated; cable suspension, tool-less height adjustment; convenient quick mounting system without tools; incl. transparent feed; direct light distribution by LGP body (Light Guiding Prism); side coupled light directed downwards by laser engraving; indirect component with special PCBs for increased luminous flux and maximum ceiling illumination; completely homogeneous illumination; energy-eff. LEDs – very good colour rendering; canopy for through wiring; optional acoustic elements available

□ Corpo illuminante a sospensione di forma rettangolare, composto da singoli elementi a L o rettangolari; Corpo illuminante in alluminio – bordi arrotondati; forma ultrapiatta (solo 15 mm); verniciatura a polvere; cavo regolabile in altezza senza attrezzi; pratico sistema di montaggio rapido senza utensili; incl. cavo di alimentazione; distribuzione della luce diretta con sistema LGP-Body (Light Guiding Prism); luce convogliata lateralmente e direzionata in basso tramite incisione laser; percentuale indiretta con piastre a flusso luminoso potenziato e massima illuminazione del soffitto; illuminazione assolutamente omogenea; LED a risp. energ. – ottima resa cromatica; rosone per cablaggio passante; in opzione elementi acustici disponibile

Quickinfo

4000 K
 CRI ≥ 90, 3 SDCM
 up to 118 lm/W
 L95 @ 50 000 h
 DALI-2
 microprismatic (UGR ≤ 19)

acoustic elements
 PET felt
 ♻️ from recycled material
 up to absorption class A
 🔥 available as B-s1, d0

Types

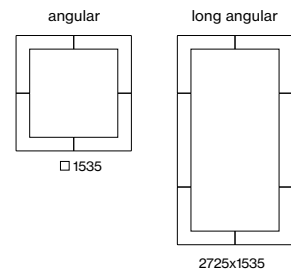

Luminaire colours



Acoustic colours



Light distribution



DiiA® standards
 251, 252, 253



click-
 system

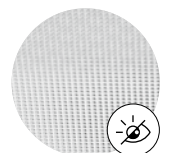

microprismatic
 (UGR ≤ 19)

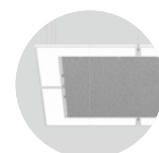

acoustic
 elements

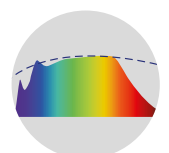

CRI ≥ 98
 XPECTRUM

Order options

COLOUR TEMPERATURE

4000 K

CONTROL

DALI-2

LUMINAIRE COLOUR

- pure white RAL 9010 7
- jet black RAL 9005 8

ACOUSTIC COLOUR

- white W
- marble grey D
- felt grey G
- black L
- special colours p. 992 X

LIGHT OPTIC COVER

microprismatic (UGR ≤ 19)

Options on request

COLOUR RENDERING INDEX

CRI ≥ 80
CRI ≥ 98 XPECTRUM

FORM

for other configurations see
TASK S suspended system

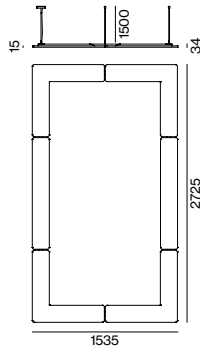
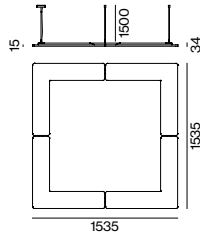

TASK angular suspended



DIRECT / INDIRECT POWER

SYSTEM POWER	COLOUR TEMP.	LUMINOUS FLUX	ORDER CODE
197 W	4000 K	↓ 15200 / ± 8050 lm	059-528313 K

TASK long angular suspended



DIRECT / INDIRECT POWER

SYSTEM POWER	COLOUR TEMP.	LUMINOUS FLUX	ORDER CODE
280 W	4000 K	↓ 22480 / ± 11620 lm	059-528413 K

Technical data

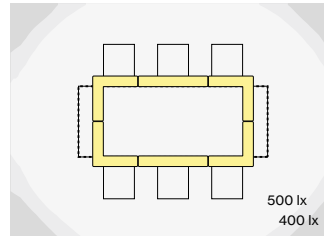

TASK long angular, 280 W, 4000 K, direct/indirect power

ROOM VALUES

Room dimensions	5.4 × 4 × 2.8 m
Reflection factor	0.7 0.5 0.2
Maintenance factor	0.8
Suspension height	2.25 m

CALCULATION SURFACE

Surface dimensions	3.2 × 1.2 m
Surface height	0.75 m
Average illuminance (E _m)	> 500 lx
Uniformity (U ₀)	> 0.6

GLARE EVALUATION

Table Classification X=4H Y=8H S=0.25H	
UGR transversal	≤ 19
UGR axial	≤ 19



Light distribution

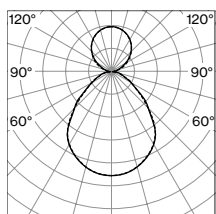

microprismatic
direct/indirect power

LUMINOUS FLUX value calculated for
CRI ≥ 90, colour white, cover microprismatic

Acoustic elements

TASK ACOUSTIC inlay

	TYPE	L-W-H (mm)	ORDER CODE
1	TASK angular suspended	1155-1155-30	059-579716 K
2	TASK long angular suspended	1155-2346-30	059-579718 K

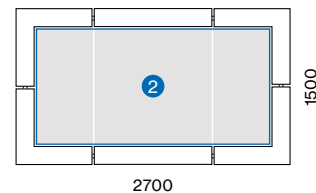
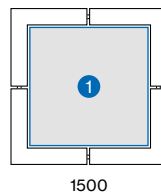

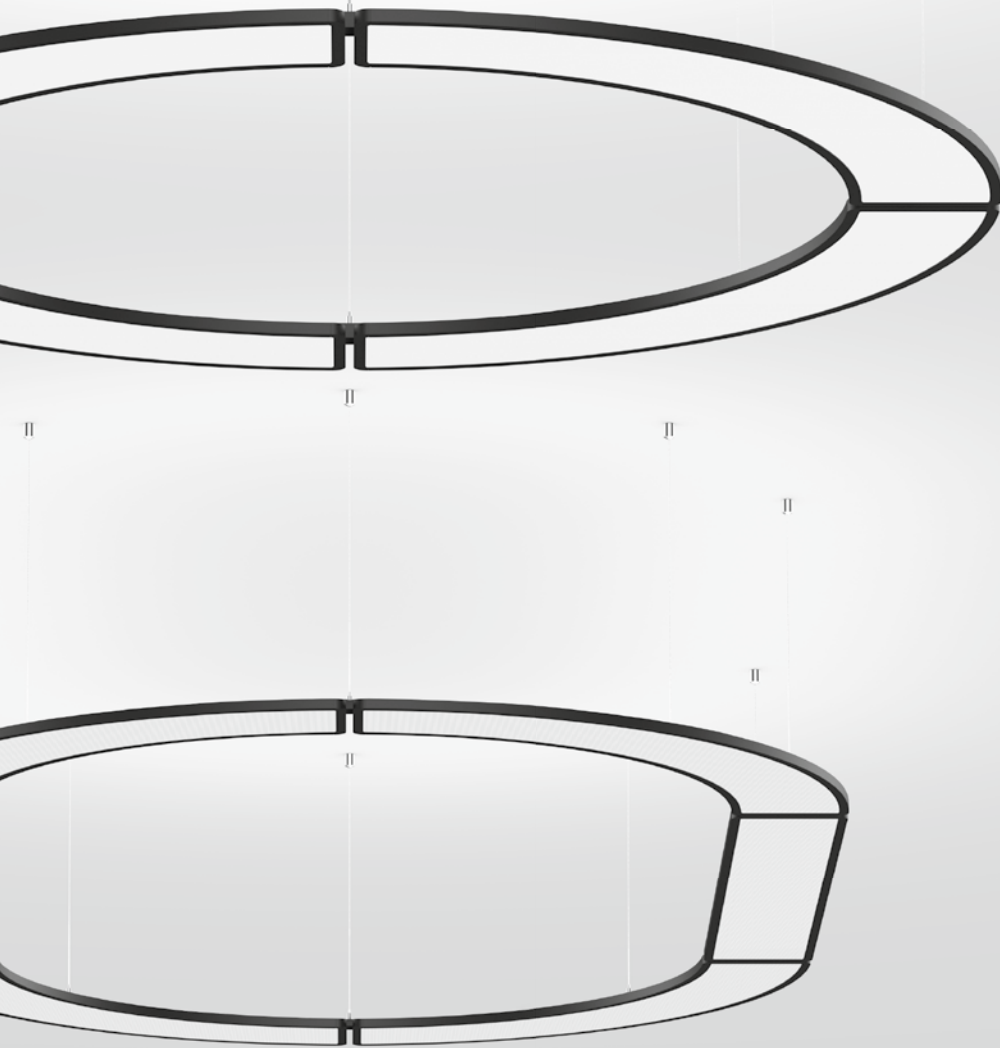

TASK circle

suspended

EN Ring-shaped suspended luminaire, consisting of single elements in quarter circle or rectangular shape; Luminaire housing made of aluminium – rounded edges; ultra low-profile design (only 15 mm); surface powder coated; cable suspension, tool-less height adjustment; convenient quick mounting system without tools; incl. feed; direct light distribution by LGP body (Light Guiding Prism); side coupled light directed downwards by laser engraving; indirect component with special PCBs for increased luminous flux and maximum ceiling illumination; completely homogeneous illumination; energy-eff. LEDs – very good colour rendering; canopy for through wiring; optional acoustic elements available

IT Corpo illuminante a sospensione di forma circolare, composto da singoli elementi in un quarto di cerchio o in una forma rettangolare; corpo illuminante in alluminio – bordi arrotondati; forma ultrapiatta (solo 15mm); verniciatura a polvere; cavo regolabile in altezza senza attrezzi; pratico sistema di montaggio rapido senza utensili; incl. cavo di alimentazione; distribuzione della luce diretta con sistema LGP-Body (Light Guiding Prism); luce convogliata lateralmente e direzionata in basso tramite incisione laser; percentuale indiretta con piastre a flusso luminoso potenziato e massima illuminazione del soffitto; illuminazione assolutamente omogenea; LED a risp. energ. – ottima resa cromatica; rosone per cablaggio passante; in opzione elementi acustici disponibile

Quickinfo

4000 K
 CRI ≥ 90, 3 SDCM
 UGR ≤ 19 / 65° ≤ 3000 cd/m²
 up to 117 lm/W
 L95 @ 50 000 h
 DALI-2
 microprismatic (UGR ≤ 19)

acoustic elements
 PET felt
 ♻️ from recycled material
 up to absorption class A
 🔥 available as B-s1, d0

Types

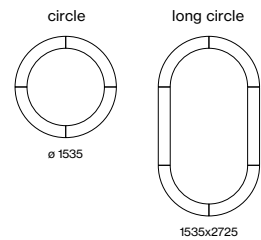

Luminaire colours



Acoustic colours



Light distribution



DiiA® standards
 251, 252, 253



click-system

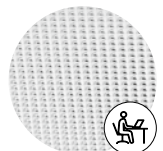

DIN EN 12464-1
 UGR ≤ 19

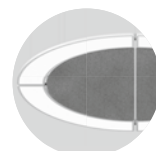

acoustic elements

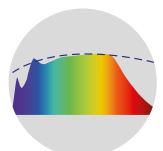

CRI ≥ 98
 XPECTRUM

Order options

COLOUR TEMPERATURE

4000 K

CONTROL

DALI-2

LUMINAIRE COLOUR

- pure white RAL 9010 7
- jet black RAL 9005 8

ACOUSTIC COLOUR

- white W
- marble grey D
- felt grey G
- black L
- special colours p. 992 X

LIGHT OPTIC COVER

microprismatic (UGR ≤ 19)

Options on request

COLOUR RENDERING INDEX

CRI ≥ 80
CRI ≥ 98 XPECTRUM

FORM

for other configurations see
TASK S suspended system

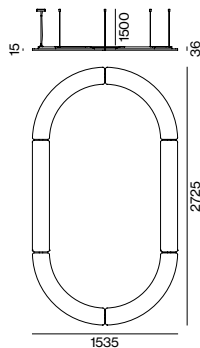
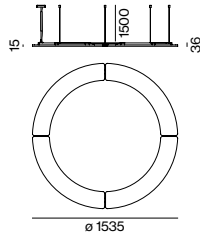

TASK circle suspended



DIRECT / INDIRECT POWER

SYSTEM POWER	COLOUR TEMP.	LUMINOUS FLUX	ORDER CODE
169 W	4000 K	↓ 12900 / ± 6870 lm	0 5 9 - 5 2 8 1 1 3 <input checked="" type="checkbox"/> K

TASK long circle suspended



DIRECT / INDIRECT POWER

SYSTEM POWER	COLOUR TEMP.	LUMINOUS FLUX	ORDER CODE
252 W	4000 K	↓ 20200 / ± 10460 lm	0 5 9 - 5 2 8 2 1 3 <input checked="" type="checkbox"/> K

Technical data

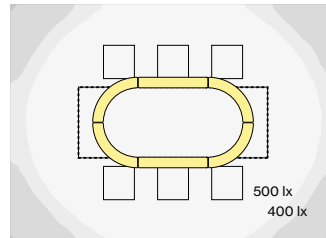

TASK long circle
252 W, 4000 K, direct/indirect power

ROOM VALUES

Room dimensions	5,4 × 4 × 2,8 m
Reflection factor	0,7 0,5 0,2
Maintenance factor	0,8
Suspension height	2,25 m

CALCULATION SURFACE

Surface dimensions	3,2 × 1,2 m
Surface height	0,75 m
Average illuminance (E _m)	> 500 lx
Uniformity (U ₀)	> 0,6

GLARE EVALUATION

Table Classification X=4H | Y=8H | S=0.25H

UGR transversal	≤ 19
UGR axial	≤ 19



Light distribution

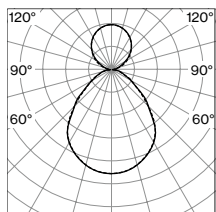

microprismatic
direct/indirect power

LUMINOUS FLUX value calculated for
CRI ≥ 90, colour white, cover microprismatic

Acoustic elements

TASK ACOUSTIC inlay

TYPE	L-W-H (mm)	ORDER CODE
1 TASK circle suspended	1155-1155-30	0 5 9 - 5 7 9 7 3 6 <input checked="" type="checkbox"/>
2 TASK long circle suspended	1155-2346-30	0 5 9 - 5 7 9 7 3 8 <input checked="" type="checkbox"/>

