



## VARO 80/110

track

**EN** Track spotlight in die-cast aluminium, available in 2 different sizes; surface powder coated; spotlight head 355° rotatable and 90° tiltable; converter installed in aluminium spotlight housing; high quality reflector with spherical facet finish; precise radiation characteristics with different beam angles; installed and exchanged without tools; optical attachments as accessories; COB (Chip on Board) technology for maximum efficiency; no multiple shadows; energy-efficient LEDs with very good colour rendering; adapter for toolless insertion or movement on a variety of 3-phase power tracks

**IT** Faretto in pressofusione di alluminio per binario elettrificato, due misure; verniciatura a polvere; testata girevole 355° e orient. 90°; converter integrato nel telaio di alluminio del faretto; riflettore di alta qualità con ottica a sfaccettature sferiche; curva fotometrica precisa con diversi angoli di emissione; montaggio e smontaggio senza utensili; unità ottiche come accessori; con tecnologia COB (Chip on Board) per la massima efficienza; assenza di ombre multiple; LED ad efficienza energetica con elevata resa cromatica; adattatore per installazione senza utensili o scorrimento in vari binari trifase

### Quickinfo

3000 K, 4000 K  
 CRI ≥ 90, 3 SDCM  
 VARO 80 up to 95 lm/W  
 VARO 110 up to 100 lm/W  
 L80/50 000 h  
 non DIM

### Types

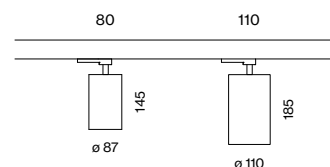

### Colours



### Light distributions



355° rotatable,  
90° tiltable

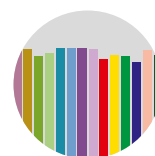

CRI ≥ 95  
2 SDCM

## Order options

<b>COLOUR TEMPERATURE</b>	••
3000K	5
4000K	6

<b>CONTROL</b>	
non DIM	

<b>MATERIAL COLOUR</b>	<input checked="" type="checkbox"/>
<input type="radio"/> traffic white RAL 9016	7
<input checked="" type="radio"/> jet black RAL 9005	8

<b>BEAM ANGLE</b>	
<b>VARO 80</b>	▲
spot 17°	S
medium 28°	M
flood 38°	F

<b>BEAM ANGLE</b>	
<b>VARO 110</b>	▲
spot 14°	S
medium 24°	M
flood 33°	F

## Options on request

<b>COLOUR RENDERING INDEX</b>	
CRI ≥ 95 2-SDCM	

<b>SPECIAL COLOUR RENDERING</b>	
vogue	CRI ≥ 90
gallery	CRI 98
gourmet	CRI ≥ 80
fresh meat & fish	CRI ≥ 80
pastry	CRI ≥ 80
brilliant white	CRI ≥ 90

## REFLECTOR

wide flood 67°	
only for VARO 110	

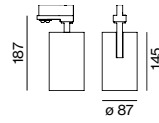

## VARO 80 track

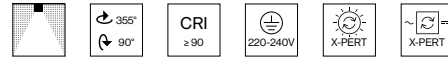

### TRACK LIGHT

<b>SYSTEM POWER</b>	<b>LUMINOUS FLUX</b>	<b>ORDER CODE</b>
29 W	2520 lm	080-6210::1▲

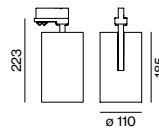

## VARO 110 track

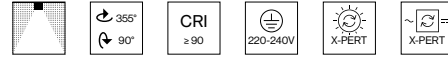

### TRACK LIGHT

<b>SYSTEM POWER</b>	<b>LUMINOUS FLUX</b>	<b>ORDER CODE</b>
42 W	3920 lm	080-6120::1▲

## Optical accessories

### SNOOT WITH HONEYCOMB LOUVER

<b>TYPE</b>	<b>Ø-H (mm)</b>	<b>ORDER CODE</b>
VARO 80	83-9	006-93120
VARO 110	106-9	006-93130

**LUMINOUS FLUX** value calculated for 3000K, CRI ≥ 90, colour white, flood 4000K +7%



**Types**

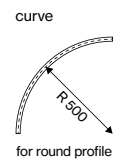
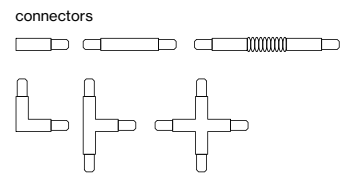
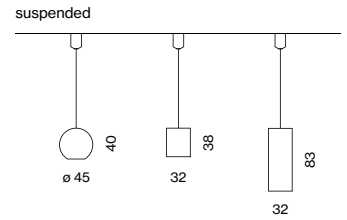
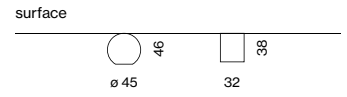
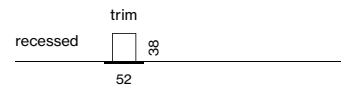

**Colours**



**TRACK 3-phase**  
recessed/surface/suspended



# TRACK recessed

## Order options

### CONTROL

non DIM

DALI-2

### MATERIAL COLOUR

- pure white RAL 9010 7
- jet black RAL 9005 8

## Pole options

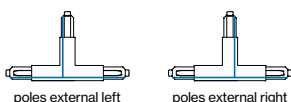
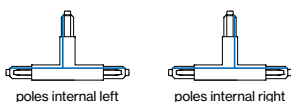

## TRACK 3-phase/3-phase + DALI-2-bus



### TRACK 240V-16A

L (mm)	ORDER CODE
2000	186-012213
3000	186-012313
4000	186-012413

end cap 186-022011

end feed left 186-022313  
 end feed right 186-022413  
 middle feed 186-021323

### CONNECTORS 240V-16A

**TYPE**      **ORDER CODE**  
 linear connector 186-021113

I-connector 186-022123

L-connector right 186-022133  
 L-connector left 186-022233

T-connector right (poles internal) 186-022143  
 T-connector left (poles internal) 186-022243  
 T-connector right (poles external) 186-022173  
 T-connector left (poles external) 186-022273

X-connector 186-022153

### MOUNTING ACCESSORIES

**TYPE**      **ORDER CODE**  
 clip 186-022511  
 cutting tool 186-021911

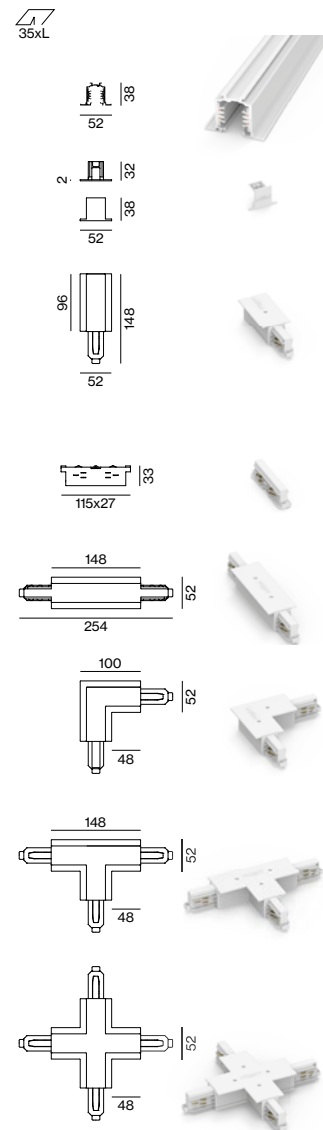

# TRACK

## surface/suspended

### Order options

#### CONTROL

non DIM

DALI-2

#### MATERIAL COLOUR

○ pure white RAL 9010	7
● white aluminium RAL 9006	6
● jet black RAL 9005	8

### Pole options

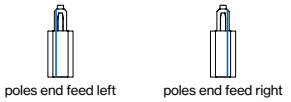
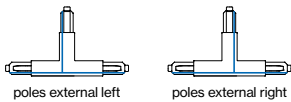
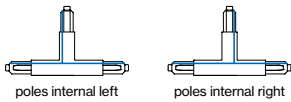

### TRACK 3-phase/3-phase + DALI-2-bus



#### TRACK 240V-16A

L (mm)	ORDER CODE
1000	186-011123
2000	186-011223
3000	186-011323
4000	186-011423

end cap 186-021011

end feed left 186-021313

end feed right 186-021413

middle feed\* 186-021323

\*only available in white and black

#### CONNECTORS 240V-16A

TYPE ORDER CODE  
 linear connector 186-021113

I-connector 186-021123

L-connector right 186-021133

L-connector left 186-021233

T-connector right (poles internal) 186-021143

T-connector left (poles internal) 186-021243

T-connector right (poles external) 186-021173

T-connector left (poles external) 186-021273

X-connector 186-021153

adjustable corner connector 186-021163

#### MOUNTING ACCESSORIES

TYPE ORDER CODE  
 ceiling clip 186-021511

pendant clip cable 186-021521

pendant clip rod 186-021541

joiner piece cable 186-021531

joiner piece rod 186-021551

cutting tool 186-0219110

#### SUSPENSION KIT

TYPE ORDER CODE  
 pendant 1000 186-021611

cable 1500 186-0217110

cable 3000 186-0217210

cable 6200 186-0217310

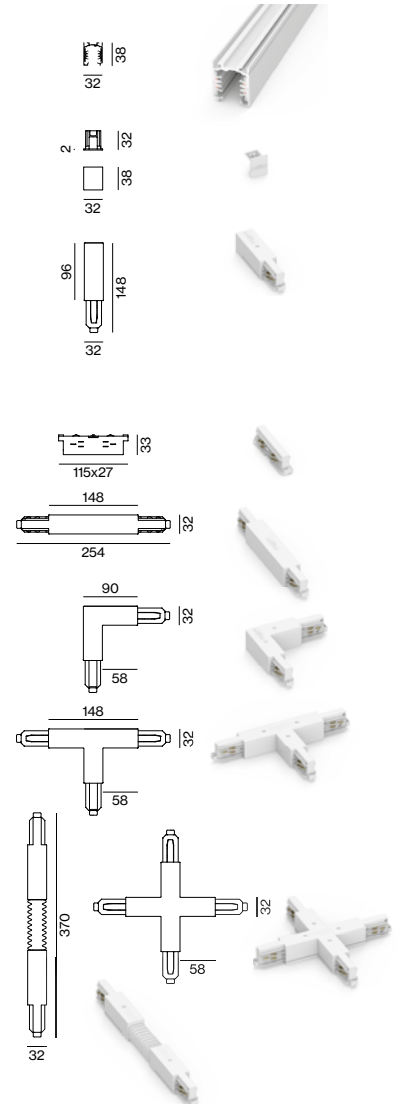

# TRACK high

## surface/suspended

### Order options

#### CONTROL

non DIM

DALI-2

#### MATERIAL COLOUR

- pure white RAL 9010 7
- jet black RAL 9005 8

### Options on request

#### LIGHT OPTIC COVER

inset indirect

### Pole options

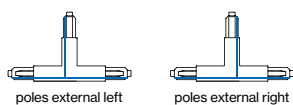
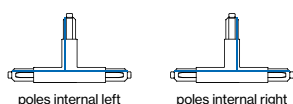

### TRACK high 3-phase/3-phase + DALI-2-bus



#### TRACK 240V-16A

L (mm)	ORDER CODE
1000	186-016113
2000	186-016213
3000	186-016313
4000	186-016413

end cap 186-026011

end feed left 186-026313

end feed right 186-026413

middle feed 186-021323

#### CONNECTORS 240V-16A

**TYPE** **ORDER CODE**

linear connector 186-026113

I-connector 186-026123

L-connector right 186-026133

L-connector left 186-026233

T-connector right (poles internal) 186-026143

T-connector left (poles internal) 186-026243

T-connector right (poles external) 186-026173

T-connector left (poles external) 186-026273

X-connector 186-026153

#### MOUNTING ACCESSORIES

**TYPE** **ORDER CODE**

pendant clip cable 186-0265210

pendant sheet metal clip 186-0215220

pendant clip rod 186-0265410

joiner piece cable 186-0265310

joiner piece rod 186-0265510

cutting tool 186-0219110

#### SUSPENSION KIT

**TYPE** **ORDER CODE**

pendant 1000 186-0216110

cable 1500 186-0217110

cable 3000 186-0217210

cable 6200 186-0217310

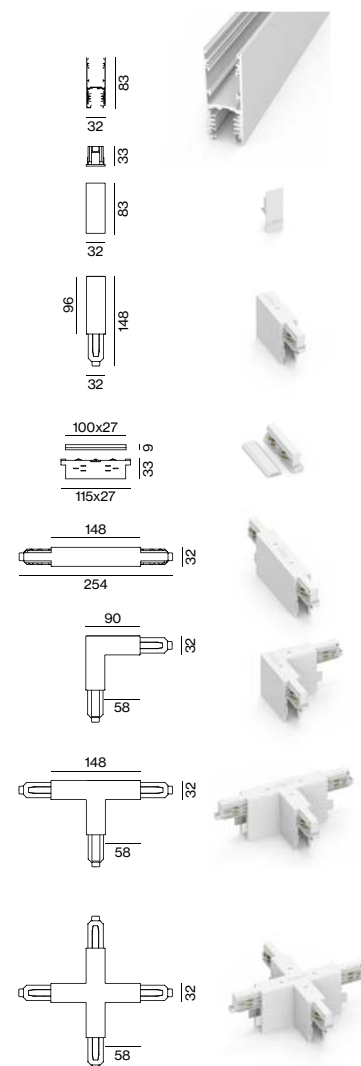

# TRACK round surface/suspended

## Order options

### CONTROL

non DIM \_\_\_\_\_  
DALI-2 \_\_\_\_\_

### MATERIAL COLOUR

○ pure white RAL 9010  7  
● jet black RAL 9005  8

## Options on request

### CONNECTOR

T-connector \_\_\_\_\_  
X-connector \_\_\_\_\_

## TRACK round 3-phase/3-phase + DALI-2-bus



### TRACK 240V-16A

L (mm)	ORDER CODE
1000	186-015113 <input checked="" type="checkbox"/>
2000	186-015213 <input checked="" type="checkbox"/>
3000	186-015313 <input checked="" type="checkbox"/>
4000	186-015413 <input checked="" type="checkbox"/>

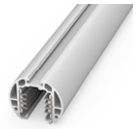

### TRACK CURVE 240V-16A

TYPE	ORDER CODE
R 500 90° left	186-015853 <input checked="" type="checkbox"/>
R 500 90° right	186-015863 <input checked="" type="checkbox"/>

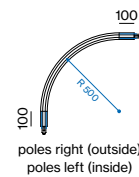

end cap \_\_\_\_\_ 186-025011

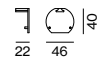

end feed left \_\_\_\_\_ 186-025313   
end feed right \_\_\_\_\_ 186-025413   
middle feed \_\_\_\_\_ 186-021323

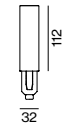

### CONNECTORS 240V-16A

linear connector \_\_\_\_\_ 186-021113

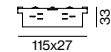

L-connector right \_\_\_\_\_ 186-025133   
L-connector left \_\_\_\_\_ 186-025233

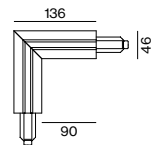

### MOUNTING ACCESSORIES

pendant clip cable \_\_\_\_\_ 186-025521   
pendant clip rod \_\_\_\_\_ 186-025541

joiner piece cable \_\_\_\_\_ 186-025531   
joiner piece rod \_\_\_\_\_ 186-025551

cutting tool \_\_\_\_\_ 186-0219110

### SUSPENSION KIT

pendant 1000 \_\_\_\_\_ 186-021611   
cable 1500 \_\_\_\_\_ 186-0217110  
cable 3000 \_\_\_\_\_ 186-0217210  
cable 6200 \_\_\_\_\_ 186-0217310