



## Description

**EN** Round or square, slim rectangular lamp made of aluminium;  $\pm 10^\circ$  rotatable; surface black or natural anodised; plug and play electrical connector system for toolless mounting; beam angle  $132^\circ$ ; passively cooled high-power LED system; available in the light colours 3000 K and 4000 K; min. 90% of the luminous flux after 50 000 hours; colour rendering  $\text{CRI} \geq 95$  ( $\text{R9} \geq 90$ ); 350 mA converter plug and play; converter separately available; degree of protection IP 20; PC I / PC II (power supply) or PC III (light insets); optionally non-dimmable or DALI-2 control

**PICO SUPPORT** round/square  
standing

**ES** Lámpara sobre soporte redonda o cuadrada esbelta de aluminio; giratorio  $\pm 10^\circ$ ; superficie anodizada negra o natural; sistema de conexión eléctrico metalizado para un montaje sin herramientas; ángulo de emisión de  $132^\circ$ ; sistema LED de alta potencia con refrigeración pasiva; disponible en 3000 K y 4000 K; mínimo 90% del flujo luminoso después de 50.000 h de vida útil; rendimiento de color  $\text{CRI} \geq 95$  ( $\text{R9} \geq 90$ ); convertidor de 350 mA prefabricado listo para enchufar; el convertidor debe encargarse por separado; protección IP 20; CP I / CP II (fuente de alimentación) o CP III (elementos de luz); opcional no atenuable o control con DALI-2

## Quickinfo

3000 K, 4000 K  
 $\text{CRI} \geq 95$  ( $\text{R9} \geq 90$ )  
 L90 @ 50 000 h  
 L 290 up to 249 lm  
 L 580 up to 498 lm  
 L 880 up to 747 lm  
 L 1180 up to 996 lm  
 non DIM, DALI-2

## Types

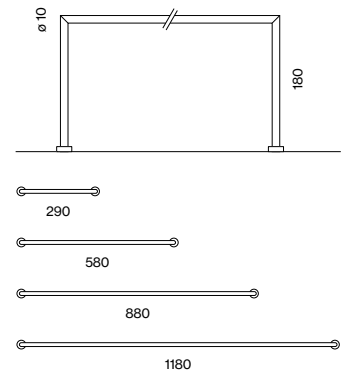

## Colours



## Light distribution



### Order options

COLOUR TEMPERATURE		☼☼
3000K	CRI≥95 70lm*	5
4000K	CRI≥95 83lm*	6

\*per LED | CRI≥95 (R9≥90) | 350mA | 53°C

MATERIAL COLOUR		☑
anodised aluminium		6
anodised black		8



### PICO SUPPORT round standing

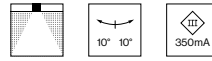

SYSTEM POWER / VOLTAGE	NO. OF LEDS	L (mm)	ORDER CODE
3×1.1W / 10V	3	290	007-4201::1☑
6×1.1W / 19V	6	580	007-4202::1☑
9×1.1W / 29V	9	880	007-4203::1☑
12×1.1W / 38V	12	1180	007-4204::1☑

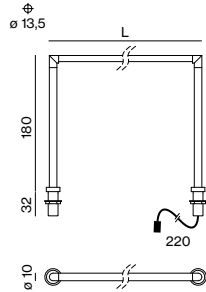

### PICO SUPPORT square standing

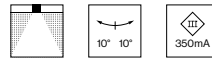

SYSTEM POWER / VOLTAGE	NO. OF LEDS	L (mm)	ORDER CODE
3×1.1W / 10V	3	290	007-4211::1☑
6×1.1W / 19V	6	580	007-4212::1☑
9×1.1W / 29V	9	880	007-4213::1☑
12×1.1W / 38V	12	1180	007-4214::1☑

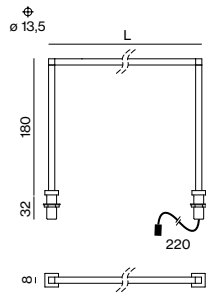

### ILLUMINANCE EXAMPLE (E<sub>max</sub> in lux)

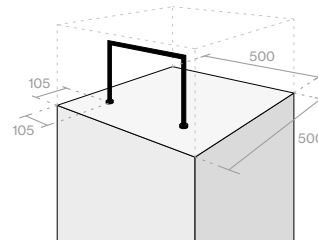

BEAM ANGLE	COLOUR TEMP.	L 290mm 1x(3x1.1W)
132°	3000K	1626

reflection factors 0.2/0.5/0.7  
maintenance factor 0.8

### LIGHT DISTRIBUTION

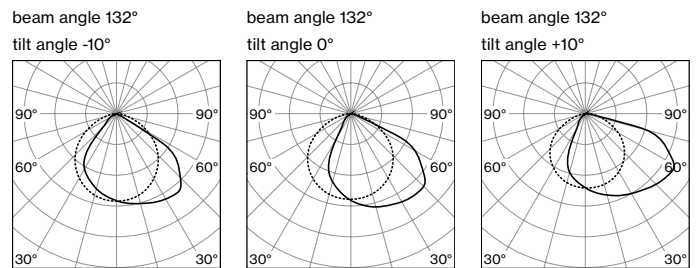

### Electrical accessories

**CONVERTER** supply 220-240V AC, 350 mA, 50-60 Hz  
incl. power cable 2m + connection cable with plug 1m

TYPE	FIXTURES	CABLE (m)	L-W-H (mm)	ORDER CODE
7W / 3-14V non DIM	☐ PC II 1-2	max. 12	68-35-21	007-1951160
30W / 2-50V non DIM	⊕ PC I 1-5	max. 18	187-30-21	007-1951560
18W / 10-54V DALI-2	☐ PC II 2-5	max. 18	147-44-30	007-1951580

### SPLITTER SERIAL, AWG22

TYPE	INPUT / OUTPUT	L-W-H (mm)	ORDER CODE
splitter 350mA + cable 500mm	1×socket / 9×plug	85-50-10	007-1959110

### EXTENSION CABLE

TYPE	INPUT / OUTPUT	L (mm)	ORDER CODE
extension cable	1×socket / 1×plug	1000	007-1961260
extension cable	1×socket / 1×plug	2000	007-1961460
extension cable	1×socket / 1×plug	4000	007-1961660