

## Description

**EN** Midget luminaire profile made of extruded aluminium; surface black or natural anodised; spot 352° rotatable and 90° tiltable; plug and play electrical connector system for toolless mounting; available in 2 (JUST 26) or 3 (JUST 16 and JUST 32) beam angles; JUST 26 and 32: optical attachments available as accessories; passively cooled high-power LED system; available in the light colours 3000K and 4000K; min. 90% of the luminous flux after 50 000 hours; colour rendering CRI ≥ 90 or CRI ≥ 95 (R9 ≥ 90); 75mm light point spacing; 700mA converter plug and play; converter separately available; degree of protection IP 20; PC II (power supply) or PC III (light insets); optionally non-dimmable or DALI-2 control

**ES** Perfil portalámparas de miniatura de aluminio extruido; superficie anodizada negra o natural; proyector giratorio 352° y orientable 90°; sistema de conexión eléctrico metalizado para un montaje sin herramientas; disponible en 2 (JUST 26) o 3 (JUST 16 y JUST 32) diferentes ángulos de emisión; JUST 26 y 32: los accesorios ópticos están disponibles como accesorios; sistema LED de alta potencia con refrigeración pasiva; disponible en 3000K y 4000K; mínimo 90% del flujo luminoso después de 50.000h de vida útil; rendimiento de color CRI ≥ 90 o CRI 95, R9 ≥ 90; distancia de punto de luz de 75mm; convertidor de 700mA prefabricado listo para enchufar; el convertidor debe encargarse por separado; protección IP 20; CP II (fuente de alimentación) o CP III (elementos de luz); opcional no atenuable o control con DALI-2

## NANO just 16/26/32

recessed

## Quickinfo

3000 K, 4000 K  
 CRI ≥ 95 (R9 ≥ 90)  
 L90 @ 50 000 h  
 JUST 16 up to 97 lm per spot  
 JUST 26 up to 170 lm per spot  
 JUST 32 up to 325 lm per spot  
 non DIM, DALI-2

## Types

JUST 16

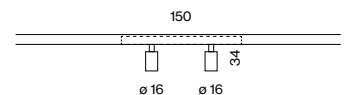

JUST 26

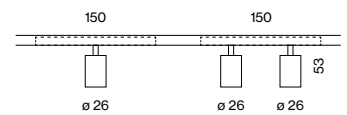

JUST 32

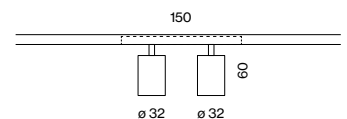

## Colours



## Light distributions



spot med. flood

### Order options

#### COLOUR TEMPERATURE

3000K CRI≥95 90lm*	5
4000K CRI≥95 97lm*	6

\*per spot | CRI≥95 (R9≥90) | 700mA | 60°C

#### MATERIAL COLOUR

anodised aluminium	6
anodised black	8



#### BEAM ANGLE

spot 20°	S
medium 30°	M
flood 40°	F



### NANO just 16

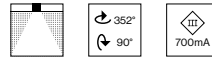

<b>SYSTEM POWER / VOLTAGE</b>	<b>NO. OF LEDES</b>	<b>L (mm)</b>	<b>ORDER CODE</b>
2x1.2W / 3V	2	150	007-4022::1

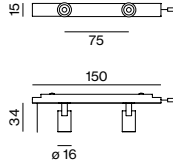

#### ILLUMINANCE EXAMPLE (E<sub>max</sub> in lux)

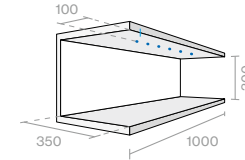

<b>BEAM ANGLE</b>	<b>COLOUR TEMP.</b>	<b>HEIGHT 0.3 m</b> 3x(2x1.2W)
20°	3000K	6467
30°	3000K	5528
40°	3000K	4445

reflection factors 0.2/0.5/0.7 | maintenance factor 0.8

#### LIGHT DISTRIBUTION

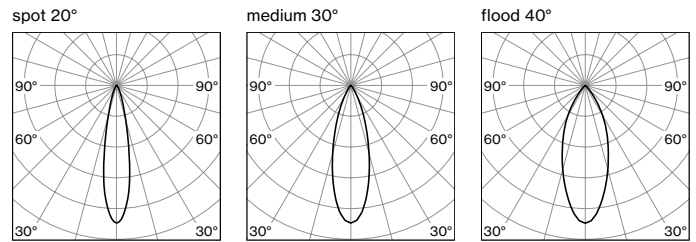

### Order options

#### LENGTH

175 mm	0
1000 mm	2
2000 mm	4
4000 mm	6

### Electrical accessories

**CONVERTER** supply 220-240 V AC, 700 mA, 50-60 Hz, PC II  
incl. power cable 2 m + connection cable with plug 1 m

TYPE	SPOTS	CABLE (m)	L-W-H (mm)	ORDER CODE
8 W / 2,5-12 V non DIM	2-6	max.18	64-34-21	007-1953110
10 W / 7-14 V non DIM	6-8	max.5	95-53-25	007-1953210
20 W / 2-28 V non DIM	2-16	max.10	111-52-22	007-1953310
45 W / 20-54 V non DIM	14-32	max.11	215-70-31	007-1953510
20 W / 2-28 V DALI-2	2-16	max.10	111-52-22	007-1953330
38 W / 10-54 V DALI-2	8-32	max.11	147-44-30	007-1953530

#### SPLITTER SERIAL, AWG22

TYPE	INPUT / OUTPUT	L-W-H (mm)	ORDER CODE
splitter 700 mA + cable 500 mm	1x socket / 9x plug	85-50-10	007-1959310
adapter cable 100 mm	1x socket / 1x plug	-	007-1963210

#### EXTENSION CABLE

TYPE	INPUT / OUTPUT	L (mm)	ORDER CODE
extension cable	1x socket / 1x plug	-	007-1961110
extension cable	2x plug	75	007-1962110
extension cable	2x plug	100	007-1962210
extension cable	2x plug	125	007-1962310

**Order options**

**COLOUR TEMPERATURE**

3000 K CRI ≥ 95 160lm*	5
4000 K CRI ≥ 95 170lm*	6

\*per spot | CRI ≥ 95 (R9 ≥ 90) | 700mA | 69°C

**MATERIAL COLOUR**

anodised aluminium	6
anodised black	8



**BEAM ANGLE**

spot 14°	S
flood 30°	F



**NANO just 26**

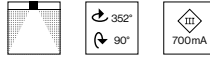

SYSTEM POWER / VOLTAGE	NO. OF LEDS	L (mm)	ORDER CODE
1x2,4 W / 3V	1	150	007-4061::1▲▲
2x2,4 W / 6V	2	150	007-4062::1▲▲

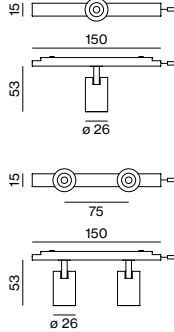

**ILLUMINANCE EXAMPLE (E<sub>max</sub> in lux)**

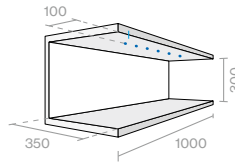

BEAM ANGLE	COLOUR TEMP.	3x(1x2,4W)	HEIGHT 0.3 m 3x(2x2,4W)
14°	3000 K	16147	17648
30°	3000 K	5255	8958

reflection factors 0.2/0.5/0.7 | maintenance factor 0.8

**LIGHT DISTRIBUTION**

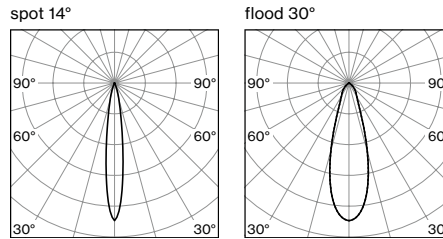

**Order options**

**LENGTH**

175 mm	0
1000 mm	2
2000 mm	4
4000 mm	6

**Electrical accessories**

**CONVERTER** supply 220-240V AC, 700mA, 50-60Hz, □ PC II  
incl. power cable 2m + connection cable with plug 1m

TYPE	SPOTS	CABLE (m)	L-W-H (mm)	ORDER CODE
8 W / 2,5-12V non DIM	1-3	max.18	64-34-21	007-1953110
10 W / 7-14V non DIM	3-4	max.5	95-53-25	007-1953210
20 W / 2-28V non DIM	1-8	max.10	111-52-22	007-1953310
45 W / 20-54V non DIM	7-16	max.11	215-70-31	007-1953510
20 W / 2-28V DALI-2	1-8	max.10	111-52-22	007-1953330
38 W / 10-54V DALI-2	7-16	max.11	147-44-30	007-1953530

**SPLITTER SERIAL, AWG22**

TYPE	INPUT / OUTPUT	L-W-H (mm)	ORDER CODE
splitter 700mA + cable 500mm	1x socket / 9x plug	85-50-10	007-1959310
adapter cable 100mm	1x socket / 1x plug	-	007-1963210

**EXTENSION CABLE**

TYPE	INPUT / OUTPUT	L (mm)	ORDER CODE
extension cable	1x socket / 1x plug	-	007-1961L10
extension cable	2x plug	75	007-1962110
extension cable	2x plug	100	007-1962210
extension cable	2x plug	125	007-1962310

**Optical accessories**

TYPE	Ø-H (mm)	ORDER CODE
honeycomb louver	23-4	007-1965148
elliptical sculpture foil	23-4	007-1965240
snoot	23-12	007-1965348
colour filter (red, blue, green, etc.)	23-4	on request

### Order options

#### COLOUR TEMPERATURE ☼☼

3000K CRI≥90 305lm*	5
4000K CRI≥90 325lm*	6

\*per spot | CRI≥90 | 350 mA | 65 °C

#### MATERIAL COLOUR ▣

anodised aluminium	6
anodised black	8



#### BEAM ANGLE ▲

spot 19°	S
medium 27°	M
flood 42°	F



### NANO just 32

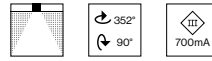

<b>SYSTEM POWER / VOLTAGE</b>	<b>NO. OF LEDS</b>	<b>L (mm)</b>	<b>ORDER CODE</b>
2x3.5W / 10V	2	150	007-4082:1▲

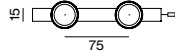

#### ILLUMINANCE EXAMPLE (E<sub>max</sub> in lux)

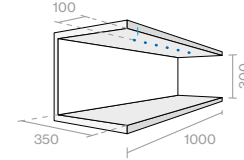
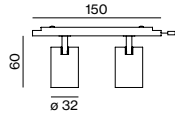

<b>BEAM ANGLE</b>	<b>COLOUR TEMP.</b>	<b>HEIGHT 0.3 m 3x(2x3.5W)</b>
19°	3000K	24017
27°	3000K	18455
42°	3000K	16713

reflection factors 0.2/0.5/0.7 | maintenance factor 0.8

#### LIGHT DISTRIBUTION

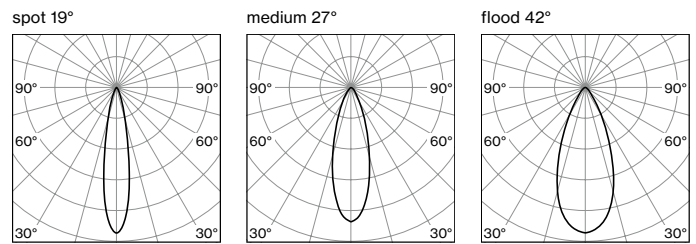

### Order options

#### LENGTH L

175 mm	0
1000 mm	2
2000 mm	4
4000 mm	6

### Electrical accessories

#### CONVERTER supply 220-240 V AC, 700 mA, 50-60 Hz, PC II

incl. power cable 2 m + connection cable with plug 1 m

TYPE	SPOTS	CABLE (m)	L-W-H (mm)	ORDER CODE
10 W / 7-14 V non DIM	2	max.18	95-53-25	007-1953210
20 W / 2-28 V non DIM	2-4	max.18	111-52-22	007-1953310
45 W / 20-54 V non DIM	6-10	max.18	215-70-31	007-1953510
20 W / 2-28 V DALI-2	2-4	max.18	111-52-22	007-1953330
38 W / 10-54 V DALI-2	4-10	max.18	147-44-30	007-1953530

#### SPLITTER SERIAL, AWG22

TYPE	INPUT / OUTPUT	L-W-H (mm)	ORDER CODE
splitter 700 mA + cable 500 mm	1x socket / 9x plug	85-50-10	007-1959310
adapter cable 100 mm	1x socket / 1x plug	-	007-1963210

#### EXTENSION CABLE

TYPE	INPUT / OUTPUT	L (mm)	ORDER CODE
extension cable	1x socket / 1x plug	-	007-1961110
extension cable	2x plug	75	007-1962110
extension cable	2x plug	100	007-1962210
extension cable	2x plug	125	007-1962310

### Optical accessories

TYPE	Ø-H (mm)	ORDER CODE
honeycomb louver	30-4	007-1965168
elliptical sculpture foil	30-4	007-1965260
snoot	30-15	007-1965368
colour filter (red, blue, green, etc.)	30-4	on request

# NANO channels

## Channel 90

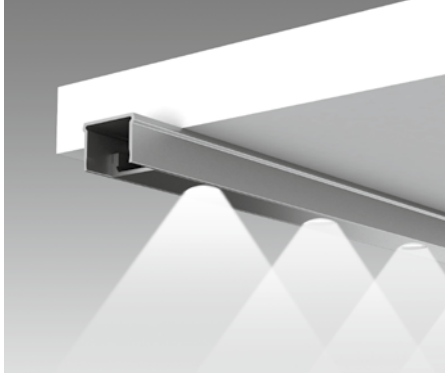

**EN** Mounting channel for NANO modules for recessed or surface mounting; also as higher variant (90+); variant with straight; for use with a beam angle of 90° onto the lower shelf; mounting tape available

**ES** Canal de montaje para módulos NANO para empotrar o adosar; adicionalmente modelo más alto (90+); terminación con corte recto; para aplicaciones con dirección de emisión de 90° sobre el estante inferior; cinta adhesiva de montaje disponible

## Channel 60



**EN** Mounting channel for NANO modules for recessed or surface mounting; with straight cut; for use with a beam angle of 60° onto the lower shelf; optimum illumination of shelf niches with equal shelf height and depth; mounting tape available

**ES** Canal de montaje para módulos NANO para empotrar o adosar; terminación con corte recto; para aplicaciones con dirección de emisión de 60° sobre el estante inferior; óptima iluminación de nichos de estantes de idéntica altura y profundidad; cinta adhesiva de montaje disponible

## Channel 45



**EN** Mounting channel for NANO modules for recessed or surface mounting; for use with a beam angle of 45° onto the lower shelf; optimum illumination of shelf niches with low height; shelf height to depth ratio of 1:2

**ES** Canal de montaje para módulos NANO para empotrar o adosar; para aplicaciones con dirección de emisión de 45° sobre el estante inferior; óptima iluminación de nichos de estantes de poca altura; relación entre altura y profundidad de estante de 1:2

### Illuminance example

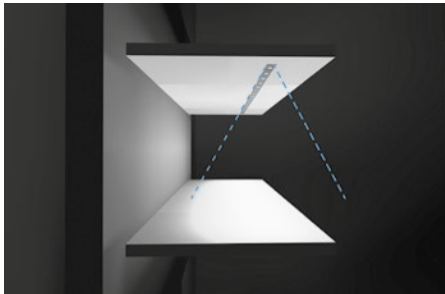

#### GENERAL

NANO turn 3×(6×1.2W)  
3000 K CRI ≥ 95 (R9 ≥ 90)  
anodised aluminium  
medium 30°

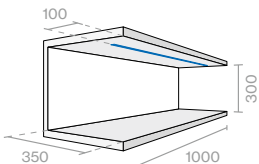

reflection factors 0.2/0.5/0.7 | maintenance factor 0.8

#### RESULT

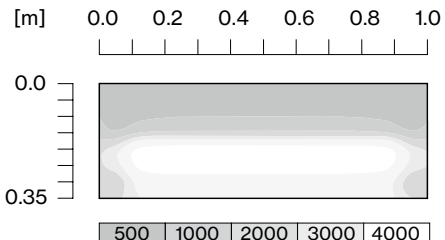

### Illuminance example

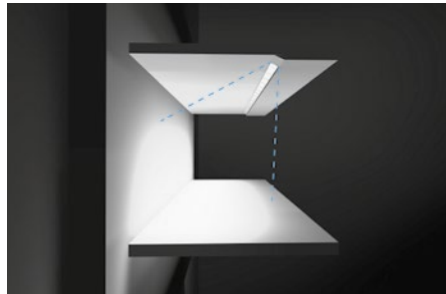

#### GENERAL

NANO turn 3×(6×1.2W)  
3000 K CRI ≥ 95 (R9 ≥ 90)  
anodised aluminium  
medium 30°

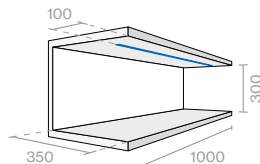

reflection factors 0.2/0.5/0.7 | maintenance factor 0.8

#### RESULT

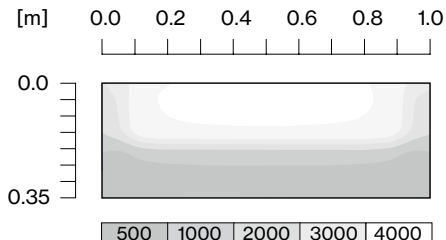

### Illuminance example

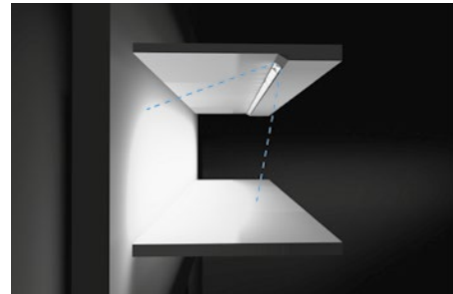

#### GENERAL

NANO turn 3×(6×1.2W)  
3000 K CRI ≥ 95 (R9 ≥ 90)  
anodised aluminium  
medium 30°

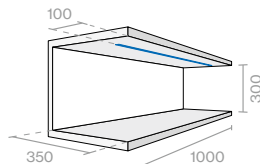

reflection factors 0.2/0.5/0.7 | maintenance factor 0.8

#### RESULT

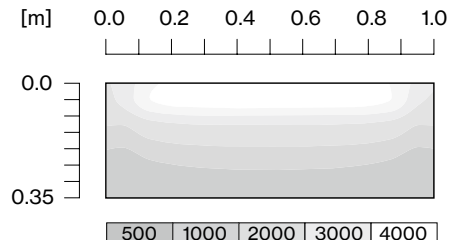

## Order options

### TYPE

straight cut



### MATERIAL COLOUR

anodised aluminium  6  
anodised black  8



## Mounting channels

### NANO CHANNEL 90

L (mm)	ORDER CODE
300	007-190104 <input checked="" type="checkbox"/>
600	007-190106 <input checked="" type="checkbox"/>
900	007-190107 <input checked="" type="checkbox"/>
1200	007-190108 <input checked="" type="checkbox"/>
3000	007-190109 <input checked="" type="checkbox"/>
custom cut (straight cut)	E 84500 ····· <input checked="" type="checkbox"/>
end caps (pair)	007-190301 <input checked="" type="checkbox"/>

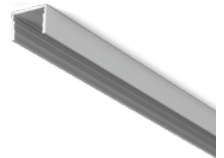

### NANO CHANNEL 90+

L (mm)	ORDER CODE
300	007-190164 <input checked="" type="checkbox"/>
600	007-190166 <input checked="" type="checkbox"/>
900	007-190167 <input checked="" type="checkbox"/>
1200	007-190168 <input checked="" type="checkbox"/>
3000	007-190169 <input checked="" type="checkbox"/>
custom cut	E 84510 ····· <input checked="" type="checkbox"/>
end caps (pair)	007-191361 <input checked="" type="checkbox"/>

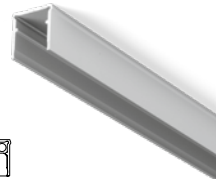
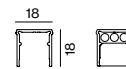

space for up to 3 pieces of power cable

### NANO CHANNEL 60

L (mm)	ORDER CODE
300	007-190114 <input checked="" type="checkbox"/>
600	007-190116 <input checked="" type="checkbox"/>
900	007-190117 <input checked="" type="checkbox"/>
1200	007-190118 <input checked="" type="checkbox"/>
3000	007-190119 <input checked="" type="checkbox"/>
custom cut	E 84520 ····· <input checked="" type="checkbox"/>
end caps (pair)	007-190311 <input checked="" type="checkbox"/>

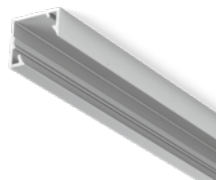
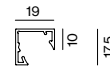

### NANO CHANNEL 45

L (mm)	ORDER CODE
300	007-190124 <input checked="" type="checkbox"/>
600	007-190126 <input checked="" type="checkbox"/>
900	007-190127 <input checked="" type="checkbox"/>
1200	007-190128 <input checked="" type="checkbox"/>
3000	007-190129 <input checked="" type="checkbox"/>
custom cut	E 84530 ····· <input checked="" type="checkbox"/>
end caps (pair)	007-190321 <input checked="" type="checkbox"/>

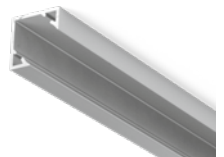
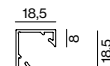

## ACCESSORIES

TYPE	ORDER CODE
blind cover 150 mm	007-190281 <input checked="" type="checkbox"/>
blind cover 300 mm	007-190284 <input checked="" type="checkbox"/>
blind cover 600 mm	007-190286 <input checked="" type="checkbox"/>
tape L 3000 mm / W 18 mm	007-191919 <input checked="" type="checkbox"/>

