



## VARO 110 S

track

**EN** Track light made of die-cast aluminium; surface powder coated; spotlight head 355° rotatable and 90° tiltable; integrated converter in the plastic adapter; high quality reflector with spherical facet finish; precise radiation characteristics with different beam angles; installed and exchanged without tools; optical attachments as accessories; optical attachments can be combined; COB (Chip on Board) technology for maximum efficiency; variants with > 120 lm/W available; no multiple shadows; energy-efficient LEDs with very good colour rendering; adapter for toolless insertion or movement on a variety of 3-phase power tracks

**ES** Proyector de carril electrificado de fundición de aluminio inyectado; superficie con recubrimiento de pintura en polvo; proyector giratorio 355° y orientable 90°; convertidor integrado en adaptador de plástico; reflector alta calidad con óptica de bisel esférica; característica de emisión precisa con diferentes ángulos de emisión; intercambiable sin herramienta; los accesorios ópticos como accesorios; accesorios ópticos combinables entre sí; con tecnología COB para proporcionar una máxima eficiencia; variantes disponibles con > 120 lm/W; no proporciona sombras múltiples; LEDs de alta eficiencia que proporcionan una alta reproducción cromática; adaptador para instalación sin herramientas o desplazamiento en diferentes carriles electrificados de 3 fases

### Quickinfo

3000 K, 3500 K, 4000 K  
CRI ≥ 90, 3 SDCM  
up to 139 lm/W  
L85/50 000 h  
non DIM, DALI-2

### Type

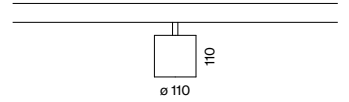

### Colours



### Light distributions



compatible with  
MOVE IT PRO



up to 139 lm/W  
(high efficiency)



355° rotatable  
90° tiltable

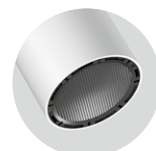

optical  
accessories



combine 2 optical  
accessories

## Order options

### COLOUR TEMPERATURE

3000K	0
3500K	2
4000K	1

### CONTROL

non DIM	1
DALI-2	3

### MATERIAL COLOUR

○ traffic white RAL 9016	7
● jet black RAL 9005	8

### BEAM ANGLE

spot 17°	S
medium 28°	M
flood 38°	F
wide flood 65°	W

## Options on request

### LUMINOUS FLUX

>5000lm	
---------	--

### CONTROL

Casambi	
---------	--

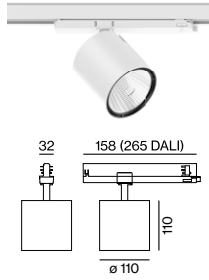

## VARO 110 S track



### HIGH EFFICIENCY

SYSTEM POWER	COLOUR TEMP.	LUMINOUS FLUX	ORDER CODE
23.4W	3000K	3200lm	180-6530
	3500K	3240lm	
	4000K	3250lm	
36W	3000K	4480lm	180-6531
	3500K	4540lm	
	4000K	4550lm	

## Optical accessories

### LENSES AND HONEYCOUMB LOUVER

TYPE	ØH (mm)	ORDER CODE
oval lens	106-9	080-6502210
wide flood lens	106-9	080-6502110W
honeycomb louver	106-9	080-6501118

### SNOOT

TYPE	ØH (mm)	ORDER CODE
short	97-23	080-6503118
medium	97-38	080-6503218
angle	97-38	080-6503318



possibility to combine different optical accessories (max. 2 pieces)



**Types**

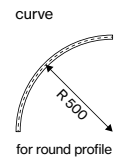
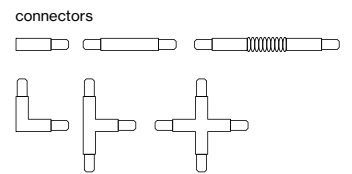
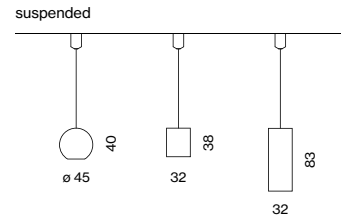
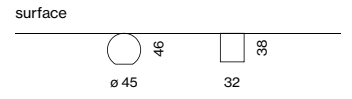
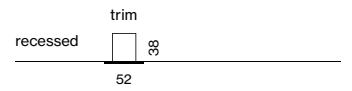

**Colours**



**TRACK 3-phase**  
recessed/surface/suspended



curve connector



optimised adapter integration

# TRACK recessed

## Order options

### CONTROL

non DIM

DALI-2

### MATERIAL COLOUR

○ pure white RAL 9010 7

● jet black RAL 9005 8

## Pole options

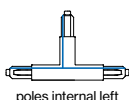

poles internal left

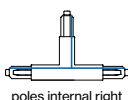

poles internal right

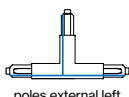

poles external left

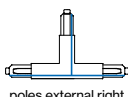

poles external right



poles end feed left



poles end feed right

## TRACK 3-phase/3-phase + DALI-2-bus



### TRACK 240V-16A

L (mm)	ORDER CODE
2000	186-012213
3000	186-012313
4000	186-012413

end cap 186-022011

end feed left 186-022313

end feed right 186-022413

middle feed 186-021323

### CONNECTORS 240V-16A

TYPE linear connector 186-021113

I-connector 186-022123

L-connector right 186-022133

L-connector left 186-022233

T-connector right (poles internal) 186-022143

T-connector left (poles internal) 186-022243

T-connector right (poles external) 186-022173

T-connector left (poles external) 186-022273

X-connector 186-022153

### MOUNTING ACCESSORIES

TYPE clip 186-0225110

cutting tool 186-0219110

35xL

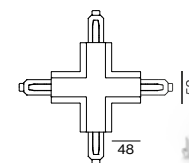
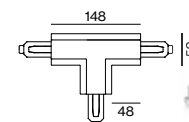
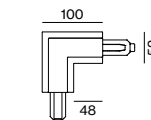
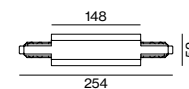
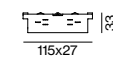
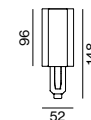

# TRACK

## surface/suspended

### Order options

#### CONTROL

non DIM  
 DALI-2

#### MATERIAL COLOUR

- pure white RAL 9010 7
- grey 6
- jet black RAL 9005 8

### Pole options

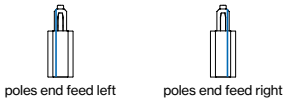
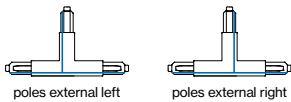
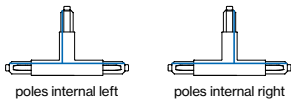

### TRACK 3-phase/3-phase + DALI-2-bus



#### TRACK 240V-16A

L (mm)	ORDER CODE
1000	186-011123
2000	186-011223
3000	186-011323
4000	186-011423

end cap 186-021011

end feed left 186-021313  
 end feed right 186-021413  
 middle feed\* 186-021323

\*only available in white and black

#### CONNECTORS 240V-16A

TYPE ORDER CODE  
 linear connector 186-021113

I-connector 186-021123

L-connector right 186-021133  
 L-connector left 186-021233

T-connector right (poles internal) 186-021143  
 T-connector left (poles internal) 186-021243  
 T-connector right (poles external) 186-021173  
 T-connector left (poles external) 186-021273

X-connector 186-021153

adjustable corner connector 186-021163

#### MOUNTING ACCESSORIES

TYPE ORDER CODE  
 ceiling clip 186-021511

pendant clip cable 186-021521  
 pendant clip rod 186-021541

joiner piece cable 186-021531  
 joiner piece rod 186-021551

cutting tool 186-0219110

#### SUSPENSION KIT

TYPE ORDER CODE  
 pendant 1000 186-021611

cable 1500 186-0217110  
 cable 3000 186-0217210  
 cable 5000 186-0217310

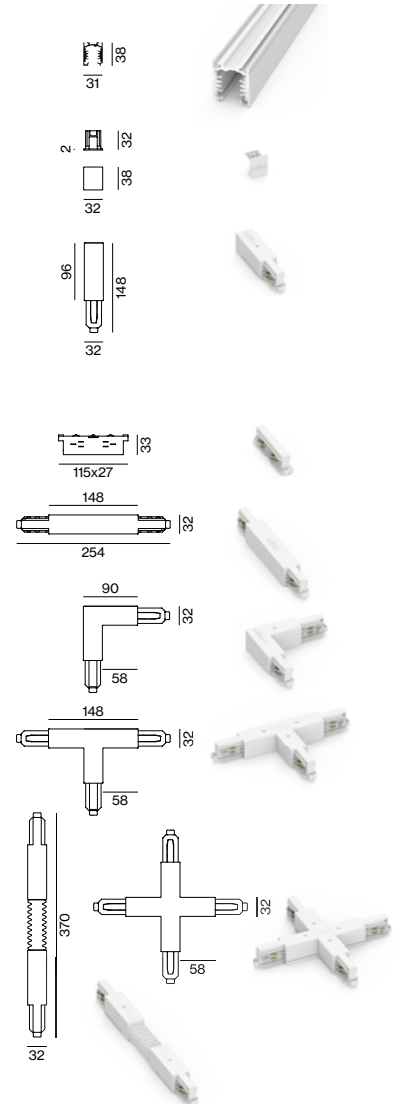

# TRACK high

## surface/suspended

### Order options

#### CONTROL

non DIM

DALI-2

#### MATERIAL COLOUR

○ pure white RAL 9010 7

● jet black RAL 9005 8

### Options on request

#### LIGHT OPTIC COVER

inset indirect

### Pole options

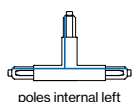

poles internal left

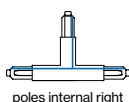

poles internal right

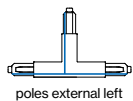

poles external left

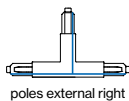

poles external right



poles end feed left



poles end feed right

### TRACK high 3-phase/3-phase + DALI-2-bus



#### TRACK 240V-16A

L (mm)	ORDER CODE
1000	186-016113
2000	186-016213
3000	186-016313
4000	186-016413

end cap 186-026011

end feed left 186-026313

end feed right 186-026413

middle feed 186-021323

#### CONNECTORS 240V-16A

TYPE ORDER CODE  
linear connector 186-026113

I-connector 186-026123

L-connector right 186-026133

L-connector left 186-026233

T-connector right (poles internal) 186-026143

T-connector left (poles internal) 186-026243

T-connector right (poles external) 186-026173

T-connector left (poles external) 186-026273

X-connector 186-026153

#### MOUNTING ACCESSORIES

TYPE ORDER CODE  
pendant clip cable 186-0265210  
pendant sheet metal clip 186-0215220  
pendant clip rod 186-0265410

joiner piece cable 186-0265310

joiner piece rod 186-0265510

cutting tool 186-0219110

#### SUSPENSION KIT

TYPE ORDER CODE  
pendant 1000 186-0216110

cable 1500 186-0217110

cable 3000 186-0217210

cable 5000 186-0217310

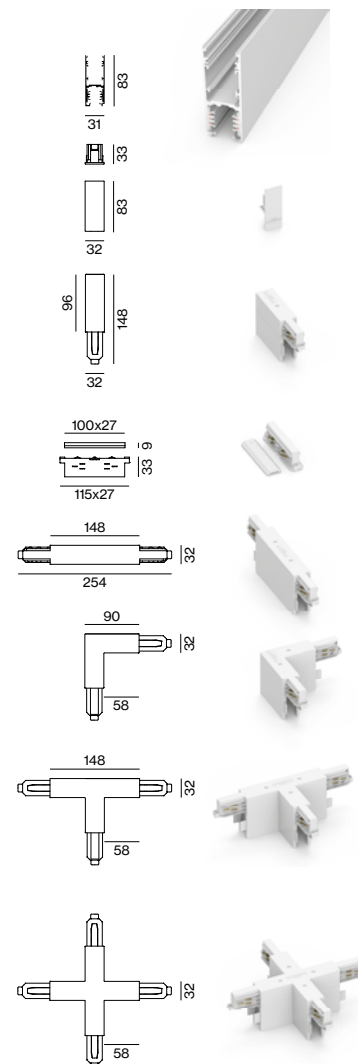

# TRACK round surface/suspended

## Order options

### CONTROL

non DIM

DALI-2

### MATERIAL COLOUR

- pure white RAL 9010 7
- jet black RAL 9005 8

## Pole options

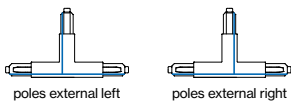
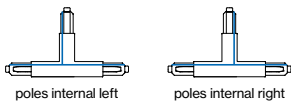

## TRACK round 3-phase/3-phase + DALI-2-bus



### TRACK 240V-16A

L (mm)	ORDER CODE
1000	186-015113
2000	186-015213
3000	186-015313
4000	186-015413



### TRACK CURVE 240V-16A

TYPE	ORDER CODE
R 500 90° left	186-015853
R 500 90° right	186-015863

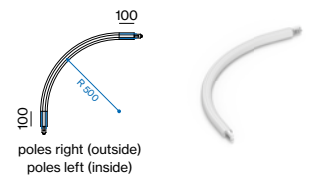

end cap	186-025011
---------	------------



end feed left	186-025313
end feed right	186-025413
middle feed	186-021323



### CONNECTORS 240V-16A

TYPE	ORDER CODE
linear connector	186-021113



L-connector right (external)	186-025133
L-connector left (internal)	186-025233

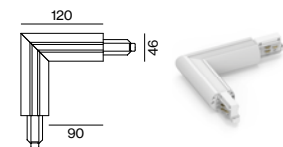

T-connector left (poles external)	186-025243
T-connector right (poles external)	186-025143
T-connector right (poles internal)	186-025273
T-connector left (poles internal)	186-025173

X-connector	186-025153
-------------	------------

### MOUNTING ACCESSORIES

TYPE	ORDER CODE
pendant clip cable	186-025521
pendant clip rod	186-025541

joiner piece cable	186-025531
joiner piece rod	186-025551

cutting tool	186-0279110
--------------	-------------

### SUSPENSION KIT

TYPE	ORDER CODE
pendant 1000	186-021611

cable 1500	186-0217110
cable 3000	186-0217210
cable 5000	186-0217310