

INSTALLATION CHANNEL

046-400201X



Project / Type

Notes

Count / Date

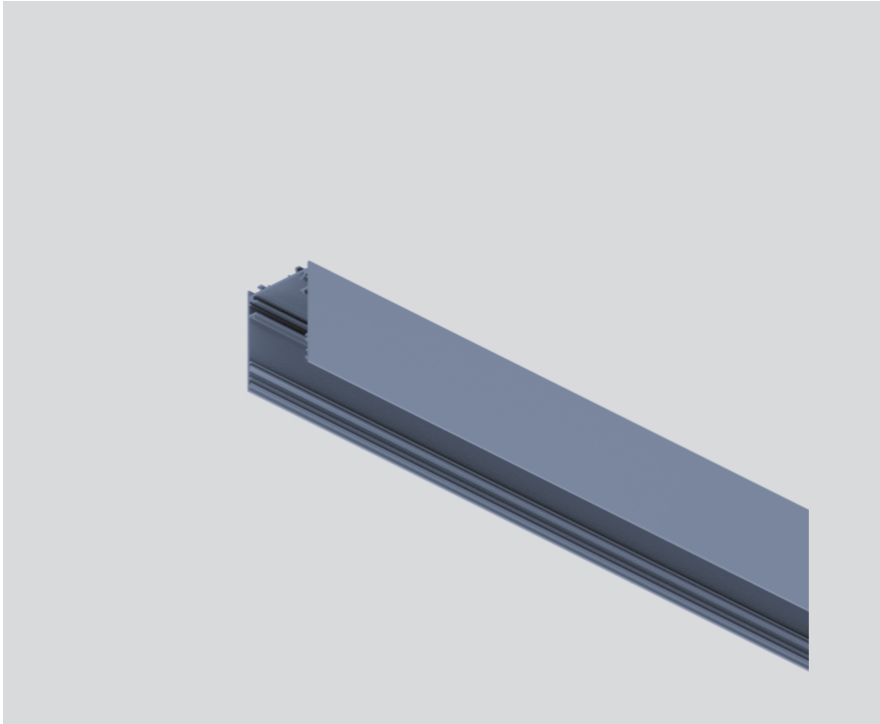

General

special colours

Physical

length 572 mm

width 60 mm

height 80 mm

0.9 kg