

# INSTALLATION CHANNEL

042-100201X



Project / Type

Notes

Count / Date

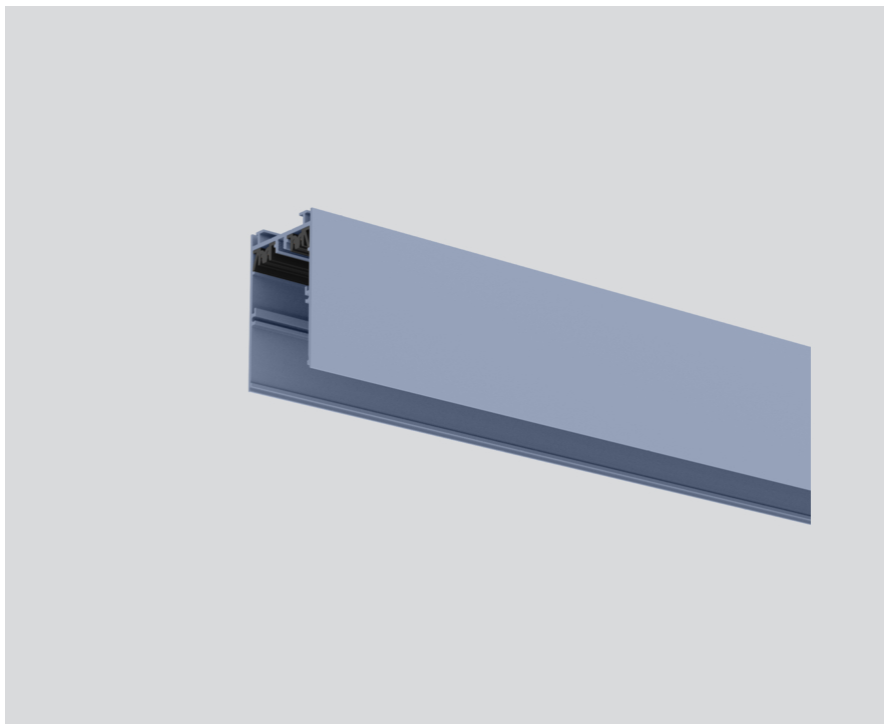

## General

special colours

## Physical

length 1000 mm

width 40 mm

height 65 mm