



reddot winner 2024



MOVE IT PRO system

trimless

EN Extruded aluminium profile with 45 mm width and 55 mm height; for trimless installation in 12.5 mm plasterboard ceilings; designed for continuous lighting systems, L / T / X connectors for flexible system design; with integrated 3-phase copper conductors + 4 emergency lighting copper conductors (2 emergency lighting circuits) + 2 DALI copper conductors for take off of supply voltage, emergency lighting power supply and DALI signal; customcut possible; surface powder coated; insets, incl. high power adapter + converter can be installed flexibly and without tools; light inserts with different patterns of light distribution, emergency light inserts (escape sign and emergency luminaires) for operation on a central battery system and sensor inserts can be integrated

DE Aluminiumstrangpressprofil mit 45 mm Breite und 55 mm Höhe; für randlosen Einbau in 12,5 mm Gipskartondecken; ausgelegt für durchgehende Lichtsysteme, L- / T- / X-Verbinder für flexiblen Systemaufbau; mit integrierten 3-Phasen Kupferleitern + 4 Notlicht-Kupferleitern (2 Notlichtkreise) + 2 DALI-Kupferleitern für Abnahme von Versorgungsspannung, Notlicht-Spannungsversorgung und DALI Signal; auf Kundenwunsch ablängbar; Oberfläche pulverbeschichtet; flexible und werkzeuglose Montage der Einsätze, inkl. High Power Adapter + Konverter; Leuchteinsätze mit unterschiedlichen Abstrahlcharakteristiken, Notlichteinsätze (Rettungszeichen- und Sicherheitsleuchten) für den Betrieb an einer Zentralbatterieanlage und Sensor-Einsätze integrierbar

Quickinfo

DALI-2

Types

recessed
trimless

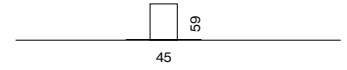

connectors



L-connector

T-connector

X-connector

Colours



up to 192lm/W
(high efficiency)

Order options

CONTROL

DALI-2

MATERIAL COLOUR

- jet black RAL 9005 8
- traffic white RAL 9016 7



MOVE IT PRO trimless

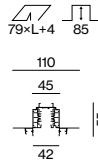
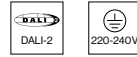

INSTALLATION TRACK 220 V – 250 V / 440 V | EM 220 V – 250 V

L (mm)	TYPE	ORDER CODE
1000	channel	086-512113 <input checked="" type="checkbox"/>
2000	channel	086-512213 <input checked="" type="checkbox"/>
3000	channel	086-512313 <input checked="" type="checkbox"/>
4000	channel	086-512413 <input checked="" type="checkbox"/>
custom cut	channel	E83810 ···· <input checked="" type="checkbox"/>

Pole options

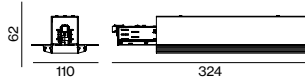
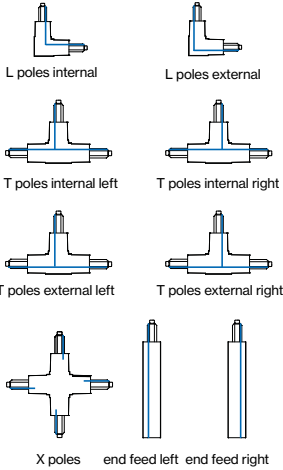

Accessories

END CAPS

TYPE	ORDER CODE
end cap	086-522011 <input checked="" type="checkbox"/>

BLIND COVER

L (mm)	TYPE	ORDER CODE
25000	blind cover	086-608250 <input checked="" type="checkbox"/>

POWER FEEDER WITH EMERGENCY CONDUCTORS

supply 220-250V / 440 V | EM 220-250 V

TYPE	ORDER CODE
end feed poles right	086-522313 <input checked="" type="checkbox"/>
end feed poles left	086-522413 <input checked="" type="checkbox"/>
middle feed	086-522323 <input checked="" type="checkbox"/>

POWER FEEDER WITHOUT EMERGENCY CONDUCTORS

supply 220-250V / 440 V

TYPE	ORDER CODE
intrack feed (incl. cable 3000mm)	086-5213338



CONNECTORS

TYPE	ORDER CODE
linear connector electrical	086-5211138
L-connector poles external	086-522133 <input checked="" type="checkbox"/>
L-connector poles internal	086-522233 <input checked="" type="checkbox"/>
L-connector mechanical	086-522230 <input checked="" type="checkbox"/>
T-connector poles internal right	086-522143 <input checked="" type="checkbox"/>
T-connector poles internal left	086-522243 <input checked="" type="checkbox"/>
T-connector poles external right	086-522173 <input checked="" type="checkbox"/>
T-connector poles external left	086-522273 <input checked="" type="checkbox"/>
T-connector (mechanical)	086-522240 <input checked="" type="checkbox"/>
X-connector	086-522153 <input checked="" type="checkbox"/>
X-connector (mechanical)	086-522150 <input checked="" type="checkbox"/>

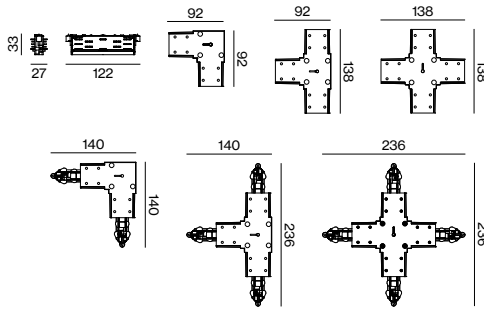

MOUNTING ACCESSORIES

TYPE	ORDER CODE
mechanical linear connector (pair)	050-2011110
conductors cutting tool	086-5219110

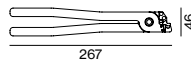

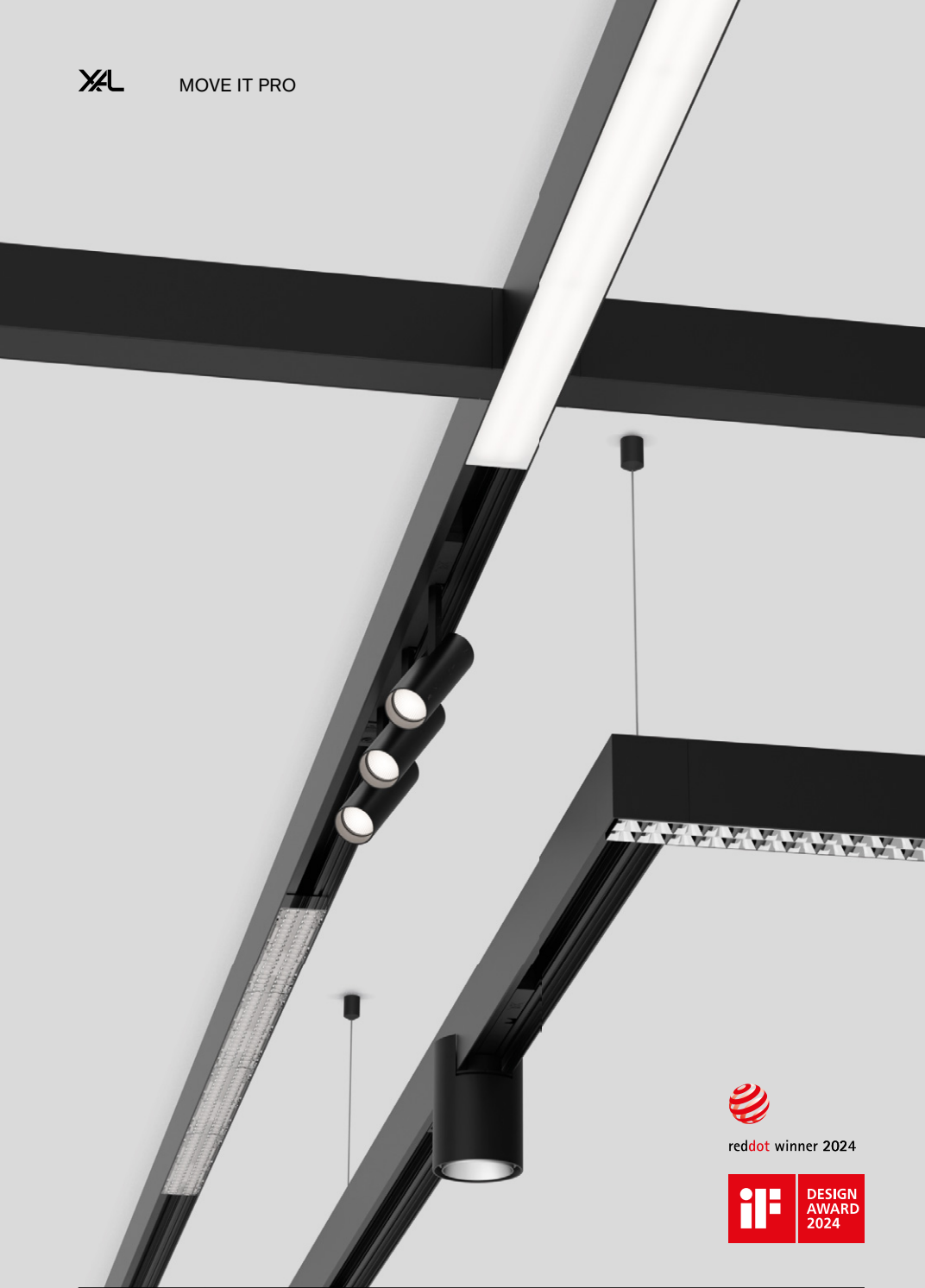

reddot winner 2024



MOVE IT PRO system

surface/suspended

EN Extruded aluminium profile with 45 mm width and 59 mm height; for ceiling surface mounting or suspended mounting (cable suspension); height adjustment without tools; designed for continuous lighting systems, L / T / X connectors for flexible system design; with integrated 3-phase copper conductors + 4 emergency lighting copper conductors (2 emergency lighting circuits) + 2 DALI copper conductors for take off of supply voltage, emergency lighting power supply and DALI signal; customcut possible; surface powder coated; insets, incl. high power adapter + converter can be installed flexibly and without tools; light inserts with different patterns of light distribution, emergency light inserts (escape sign and emergency luminaires) for operation on a central battery system and sensor inserts can be integrated

DE Aluminiumstrangpressprofil mit 45 mm Breite und 59 mm Höhe; für Deckenanbaumontage oder für abgehängte Montage (Seilabhängung); werkzeuglose Höhenverstellung; ausgelegt für durchgehende Lichtsysteme, L- / T- / X-Verbinder für flexiblen Systemaufbau; mit integrierten 3-Phasen Kupferleitern + 4 Notlicht-Kupferleitern (2 Notlichtkreise) + 2 DALI-Kupferleitern für Abnahme von Versorgungsspannung, Notlicht-Spannungsversorgung und DALI Signal; auf Kundenwunsch ablängbar; Oberfläche pulverbeschichtet; flexible und werkzeuglose Montage der Einsätze, inkl. High Power Adapter + Konverter; Lichteinsätze mit unterschiedlichen Abstrahlcharakteristiken, Notlichteinsätze (Rettungszeichen- und Sicherheitsleuchten) für den Betrieb an einer Zentralbatterieanlage und Sensor-Einsätze integrierbar

Quickinfo

DALI-2

Types

surface suspended

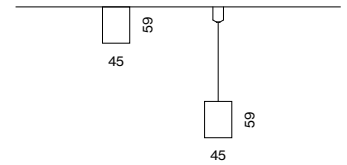

connectors



L-connector

T-connector

X-connector

Colours



up to 192 lm/W
(high efficiency)

Order options

CONTROL

DALI-2

MATERIAL COLOUR	
● jet black RAL 9005	8
○ traffic white RAL 9016	7

MATERIAL COLOUR	
CABLE SUSPENSION	
black	8
chrome	0



MOVE IT PRO surface/suspended

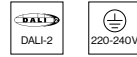

INSTALLATION TRACK 220V-250V/440V | EM 220V-250V

L (mm)	TYPE	ORDER CODE
1000	channel	086-511113
2000	channel	086-511213
3000	channel	086-511313
4000	channel	086-511413
custom cut	channel	E83820



Pole options

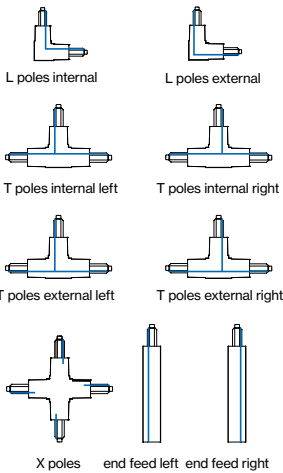

Accessories

END CAPS

TYPE	ORDER CODE
end cap	086-521011

BLIND COVER

L (mm)	TYPE	ORDER CODE
25000	blind cover	086-608250

POWER FEEDER WITH EMERGENCY CONDUCTORS

supply 220-250V/440V | EM 220-250V

TYPE	ORDER CODE
end feed poles right	086-521413
end feed poles left	086-521313
middle feed	086-521323

POWER FEEDER WITHOUT EMERGENCY CONDUCTORS

supply 220-250V/440V

TYPE	ORDER CODE
intrack feed (incl. cable 3000mm)	086-5213338

CONNECTORS

TYPE	ORDER CODE
linear connector electrical	086-5211138
L-connector poles external	086-521133
L-connector poles internal	086-521233
L-connector mechanical	086-521230
T-connector poles internal right	086-521143
T-connector poles internal left	086-521243
T-connector poles external right	086-521173
T-connector poles external left	086-521273
T-connector (mechanical)	086-521240
X-connector	086-521153
X-connector (mechanical)	086-521150

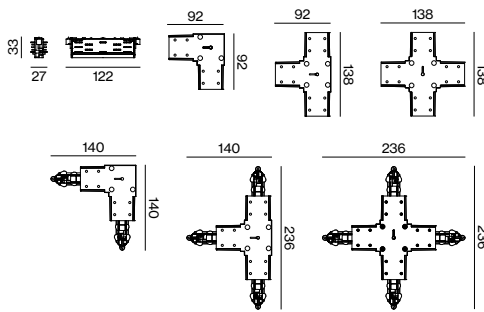

MOUNTING ACCESSORIES

TYPE	ORDER CODE
ceiling fastener	086-521511
suspension bracket	086-521521
linear suspension connector (mechanical)	086-521531
conductors cutting tool	086-5219110
drilling template for indirect inset	086-5219510

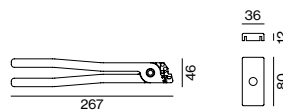
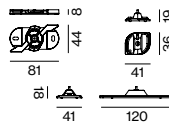

CABLE SUSPENSION

TYPE	L (mm)	ORDER CODE
cable suspension	1500	086-521711
cable suspension	3000	086-521721
cable suspension	6000	086-521731
connector cable suspension	1500	058-301811
connector cable suspension	3000	058-301821
connector cable suspension	6000	058-301831
tool for connector cable suspension		050-2049210

Quickinfo

2700 K, 3000 K, 3500 K, 4000 K
 CRI \geq 80, CRI \geq 90, 3 SDCM
 UGR \leq 19 / 65° \leq 1500 cd/m²
 up to 187 lm/W
 up to 2940 lm/m
 L90 @ 50 000 h
 DALI-2

Types

louver



Colours



Light distribution



super
wide
flood



reddot winner 2024



LOUVER

linear inset

EN Linear light inset made of plastic; light inset, incl. high power adapter + converter can be installed flexibly and without tools; flush with profile system; high quality reflector with micro-faceted, aluminum-vaporised surface; precise radiation characteristic with symmetrical light distribution; for use in schools and offices; energy-efficient LEDs with very good colour rendering

DE Linear-Lichteinsatz aus Kunststoff; Lichteinsatz, inkl. High Power Adapter + Konverter, werkzeuglos einsetz- und verschiebbar; bündig im Profilsystem; hochwertiger Reflektor mit mikrofaccettierter, aluminiumbedampfter Oberfläche; präzise Abstrahlcharakteristik mit symmetrischer Lichtverteilung; für den Einsatz in Schulen und im Bürobereich; energieeffiziente LEDs mit sehr guter Farbwiedergabe

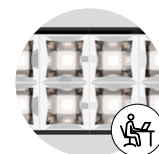

DIN EN 12464-1
UGR \leq 19



up to 187 lm/W
(high efficiency)

Order options

COLOUR TEMPERATURE

2700K CRI ≥ 90	9
3000K CRI ≥ 90	0
3500K CRI ≥ 90	2
4000K CRI ≥ 90	1
2700K CRI ≥ 80	4
3000K CRI ≥ 80	5
3500K CRI ≥ 80	7
4000K CRI ≥ 80	6

CONTROL

DALI-2

LIGHT OPTIC

super wide flood 74°

MATERIAL COLOUR

chrome reflector	4
black reflector	8

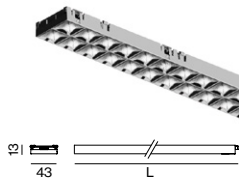

LOUVER inset



REFLECTOR WIDE

SYSTEM POWER	COLOUR TEMP.	LUM. FLUX	L (mm)	ORDER CODE
18.4W	2700K	2580lm	1000	0 8 6 - 6 4 1 0 :: 3 X
	3000K	2580lm		
	3500K	2760lm		
	4000K	2940lm		
26.7W	2700K	3870lm	1500	0 8 6 - 6 4 2 0 :: 3 X
	3000K	3870lm		
	3500K	4140lm		
	4000K	4400lm		
34W	2700K	5160lm	2000	0 8 6 - 6 4 3 0 :: 3 X
	3000K	5160lm		
	3500K	5520lm		
	4000K	5870lm		
41W	2700K	6450lm	2500	0 8 6 - 6 4 4 0 :: 3 X
	3000K	6450lm		
	3500K	6890lm		
	4000K	7340lm		
47W	2700K	7740lm	3000	0 8 6 - 6 4 5 0 :: 3 X
	3000K	7740lm		
	3500K	8270lm		
	4000K	8810lm		

Quickinfo

2700 K, 3000 K, 3500 K, 4000 K
 CRI ≥ 80, CRI ≥ 90, 3 SDCM
 up to 162 lm/W
 up to 4960 lm/m
 L90 @ 50 000 h
 DALI-2

Types

shelf floor washer

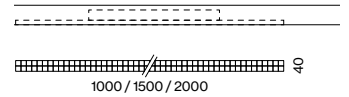

wallwasher

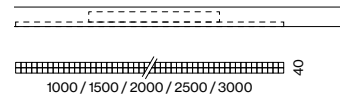

Colours



Light distributions



shelf floor washer 1-sided
 shelf floor washer 2-sided
 wall washer 1-sided



reddot winner 2024



SHELF FLOOR WASHER

linear inset

EN Linear light inset made of plastic; light inset, incl. high power adapter + converter can be installed flexibly and without tools; flush with profile system; high quality reflector with micro-faceted, aluminum-vaporised surface; with special, multi-free-form, facet effect surface reflectors for high precision light control; precise shelf and aisle zone lighting, optimum longitudinal glare control for high viewing comfort in the aisle zone; for use in grocery and fashion; energy-efficient LEDs with very good colour rendering

DE Linear-Lichteinsatz aus Kunststoff; Lichteinsatz, inkl. High Power Adapter + Konverter, werkzeuglos einsetz- und verschiebbar; bündig im Profilsystem; hochwertiger Reflektor mit mikrofaccettierter, aluminiumbedampfter Oberfläche; mit speziellen Multi-Freiformflächenreflektoren mit Facettenoptik zur äußerst präzisen Lichtlenkung; punktgenaue Regal- und Gangzonenausleuchtung, optimale Längsentblendung für hohen Sehkomfort in der Gangzone; für den Einsatz im Lebensmittelhandel und Fashionbereich; energieeffiziente LEDs mit sehr guter Farbwiedergabe



glare-free reflector
longitudinally

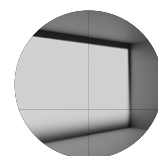

precision
cut-off



up to 162 lm/W
(high efficiency)

Order options

COLOUR TEMPERATURE

2700 K CRI ≥ 90	9
3000 K CRI ≥ 90	0
3500 K CRI ≥ 90	2
4000 K CRI ≥ 90	1
2700 K CRI ≥ 80	4
3000 K CRI ≥ 80	5
3500 K CRI ≥ 80	7
4000 K CRI ≥ 80	6

CONTROL

DALI-2

LIGHT OPTIC

shelf / floor washer single	W
shelf / floor washer	Y
wallwasher	

MATERIAL COLOUR

chrome reflector	4
black reflector	8

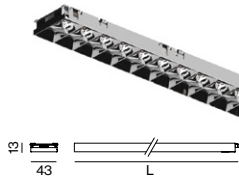

SHELF FLOOR WASHER inset

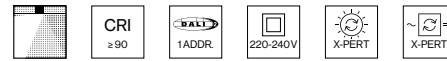

SHELF / FLOOR WASHER LOW POWER

SYSTEM POWER	COLOUR TEMP.	LUM. FLUX	L (mm)	ORDER CODE
22.1W	3000K	2960lm	1000	0 8 6 - 6 6 1 0 :: 3
	4000K	3370lm		
33.1W	3000K	4440lm	1500	0 8 6 - 6 6 2 0 :: 3
	4000K	5050lm		
42W	3000K	5930lm	2000	0 8 6 - 6 6 3 0 :: 3
	4000K	6740lm		

SHELF / FLOOR WASHER HIGH POWER

SYSTEM POWER	COLOUR TEMP.	LUM. FLUX	L (mm)	ORDER CODE
32W	3000K	4360lm	1000	0 8 6 - 6 6 1 5 :: 3
	4000K	4960lm		
48W	3000K	6540lm	1500	0 8 6 - 6 6 2 5 :: 3
	4000K	7440lm		

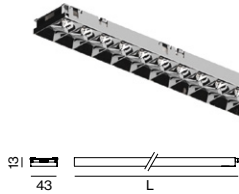

WALLWASHER inset



REFLECTOR WALLWASHER

SYSTEM POWER	COLOUR TEMP.	LUM. FLUX	L (mm)	ORDER CODE
16.5W	3000K	2180lm	1000	0 8 6 - 6 4 1 0 :: 3
	4000K	2490lm		
24.8W	3000K	3280lm	1500	0 8 6 - 6 4 2 0 :: 3
	4000K	3730lm		
33W	3000K	4370lm	2000	0 8 6 - 6 4 3 0 :: 3
	4000K	4980lm		
41W	3000K	5460lm	2500	0 8 6 - 6 4 4 0 :: 3
	4000K	5220lm		
47W	3000K	6550lm	3000	0 8 6 - 6 4 5 0 :: 3
	4000K	7470lm		

Quickinfo

3000 K, 3500 K, 4000 K
 CRI \geq 80, CRI \geq 90, 3 SDCM
 UGR \leq 19
 up to 192 lm/W
 up to 2940 lm/m
 L90 @ 50 000 h
 DALI-2

Types

lens

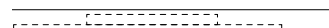

Colour



Light distribution



wide
flood



reddot winner 2024



LENS

linear inset

EN Linear light inset made of plastic; light inset, incl. high power adapter + converter can be installed flexibly and without tools; flush with profile system; equipped with specially computed wide beam lenses; precise radiation characteristic with symmetrical light distribution; for use in schools and offices; energy-efficient LEDs with very good colour rendering

DE Linear-Lichteinsatz aus Kunststoff; Lichteinsatz, inkl. High Power Adapter + Konverter, werkzeuglos einsetz- und verschiebbar; bündig im Profilsystem; bestückt mit speziell berechneten wide beam Linsen; präzise Abstrahlcharakteristik mit symmetrischer Lichtverteilung; für den Einsatz in Schulen und im Bürobereich; energieeffiziente LEDs mit sehr guter Farbwiedergabe



DIN EN 12464-1
UGR \leq 19



up to 192 lm/W
(high efficiency)

Order options

COLOUR TEMPERATURE

3000 K CRI ≥ 90	0
3500 K CRI ≥ 90	2
4000 K CRI ≥ 90	1
3000 K CRI ≥ 80	5
3500 K CRI ≥ 80	7
4000 K CRI ≥ 80	6

CONTROL

DALI-2

LIGHT OPTIC

wide flood 68°

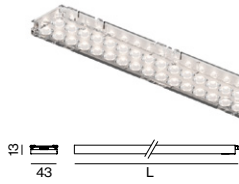

LENS inset



LENS WIDE

SYSTEM POWER	COLOUR TEMP.	LUM. FLUX	L (mm)	ORDER CODE
18.2 W	3000 K	2590 lm	1000	0 8 6 - 6 7 1 0 30 W
	3500 K	2770 lm		
	4000 K	2940 lm		
26.4 W	3000 K	3880 lm	1500	0 8 6 - 6 7 2 0 30 W
	3500 K	4150 lm		
	4000 K	4420 lm		
33 W	3000 K	5170 lm	2000	0 8 6 - 6 7 3 0 30 W
	3500 K	5530 lm		
	4000 K	5890 lm		
41 W	3000 K	6470 lm	2500	0 8 6 - 6 7 4 0 30 W
	3500 K	6910 lm		
	4000 K	7360 lm		
46 W	3000 K	7760 lm	3000	0 8 6 - 6 7 5 0 30 W
	3500 K	8300 lm		
	4000 K	8830 lm		

Quickinfo

2700 K, 3000 K, 3500 K, 4000 K
 CRI \geq 80, CRI \geq 90, 3 SDCM
 up to 163 lm/W
 up to 2590 lm/m
 L90 @ 50 000 h
 DALI-2

Types

lens wallwasher

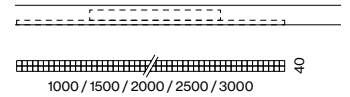

Colour



Light distribution



wall
wash.



reddot winner 2024



LENS

linear inset

EN Linear light inset made of plastic; light inset, incl. high power adapter + converter can be installed flexibly and without tools; flush with profile system; equipped with specially computed wallwasher lenses; precise radiation characteristic with asymmetrical light distribution; energy-efficient LEDs with very good colour rendering

DE Linear-Lichteinsatz aus Kunststoff; Lichteinsatz, inkl. High Power Adapter + Konverter, werkzeuglos einsetz- und verschiebbar; bündig im Profilsystem; bestückt mit speziell berechneten wallwasher Linsen; präzise Abstrahlcharakteristik mit asymmetrischer Lichtverteilung; energieeffiziente LEDs mit sehr guter Farbwiedergabe



up to 190 lm/W
(high efficiency)

Order options

COLOUR TEMPERATURE ☼☼

2700 K CRI ≥ 90	9
3000 K CRI ≥ 90	0
3500 K CRI ≥ 90	2
4000 K CRI ≥ 90	1
2700 K CRI ≥ 80	4
3000 K CRI ≥ 80	5
3500 K CRI ≥ 80	7
4000 K CRI ≥ 80	6

CONTROL

DALI-2

LIGHT OPTIC

wallwasher

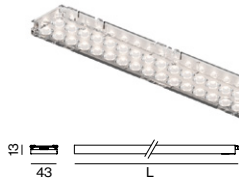

LENS inset



LENS WALLWASHER

SYSTEM POWER	COLOUR TEMP.	LUM. FLUX	L (mm)	ORDER CODE
18.4W	3000K	2270lm	1000	0 8 6 - 6 7 1 0 ☼☼ 30 A
	4000K	2590lm		
26.7W	3000K	3330lm	1500	0 8 6 - 6 7 2 0 ☼☼ 30 A
	4000K	3790lm		
34W	3000K	4440lm	2000	0 8 6 - 6 7 3 0 ☼☼ 30 A
	4000K	5050lm		
41W	3000K	5550lm	2500	0 8 6 - 6 7 4 0 ☼☼ 30 A
	4000K	6310lm		
46W	3000K	6650lm	3000	0 8 6 - 6 7 5 0 ☼☼ 30 A
	4000K	7580lm		

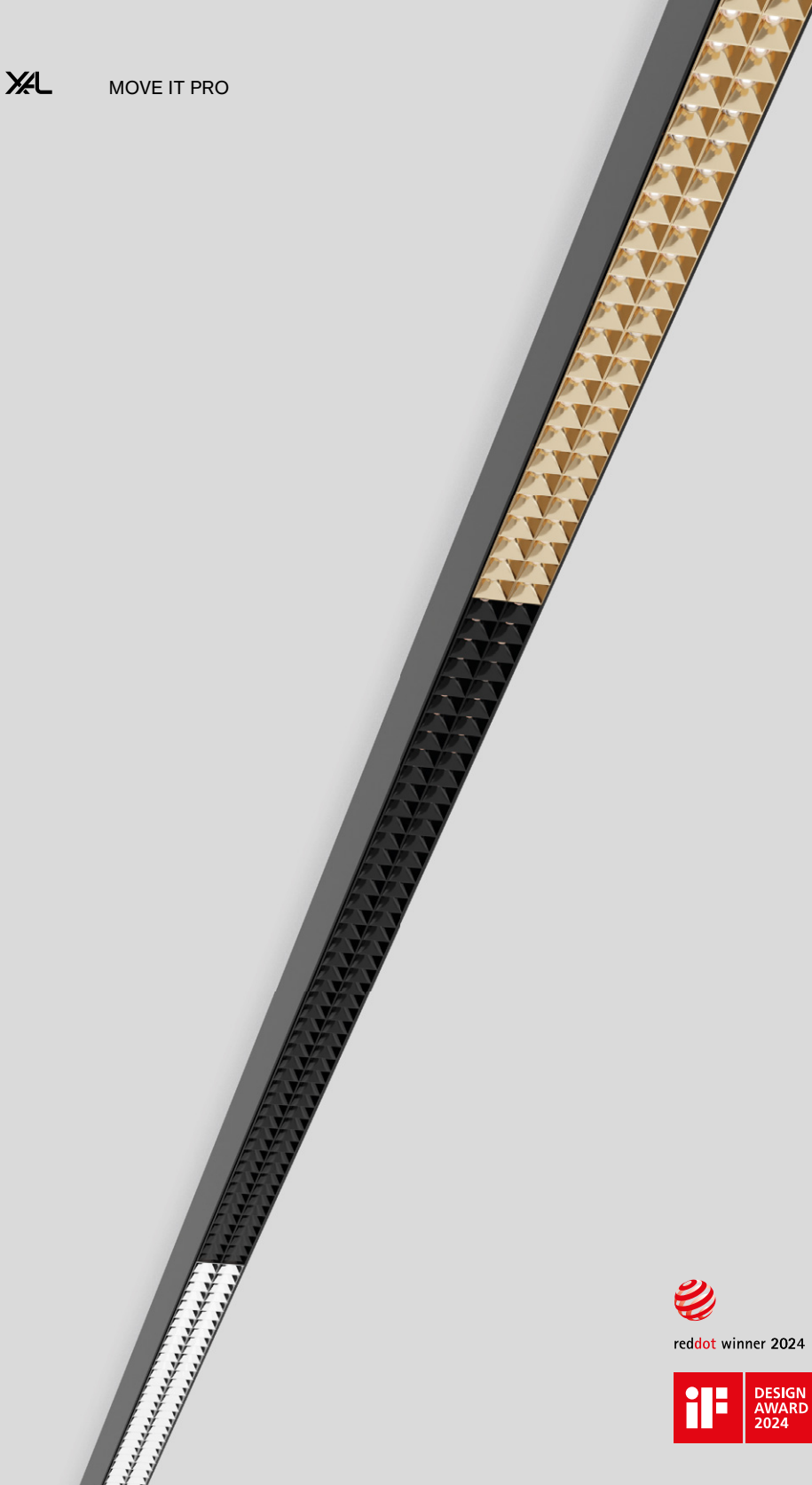

Quickinfo

2700 K, 3000 K, 3500 K, 4000 K
 CRI ≥ 80, CRI ≥ 90, 3 SDCM
 UGR ≤ 16, 19 / 65° ≤ 1500 cd/m²
 up to 179 lm/W
 up to 2800 lm/m
 L90 @ 50 000 h
 DALI-2

Types

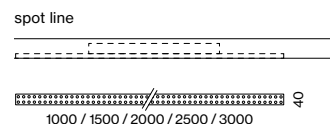

Colours



Light distributions



SPOT LINE

linear inset

EN Linear light inset made of plastic; light inset, incl. high power adapter + converter can be installed flexibly and without tools; flush with profile system; fitted with single LED light points; good glare reduction due to recessed light point plane; despite this increased efficiency through special lens technology; inserted lenses with medium or wide flood radiation characteristic; for use in schools, retail and offices; energy-efficient LEDs with very good colour rendering

DE Linear-Lichteinsatz aus Kunststoff; Lichteinsatz, inkl. High Power Adapter + Konverter, werkzeuglos einsetz- und verschiebbar; bündig im Profilsystem; bestückt mit LED Einzellichtpunkten; gute Entblendung durch zurückversetzte Lichtpunktebene; trotzdem erhöhte Effizienz durch spezielle Linsentechnik; eingesetzte Linsen mit medium oder wide flood Strahlungscharakteristik; für den Einsatz in Schulen, Retail- und im Bürobereich; energieeffiziente LEDs mit sehr guter Farbwiedergabe

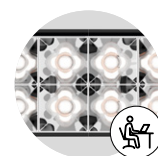

DIN EN 12464-1
 UGR ≤ 16



up to 179 lm/W
 (high efficiency)

Order options

COLOUR TEMPERATURE

2700K CRI ≥ 90	9
3000K CRI ≥ 90	0
3500K CRI ≥ 90	2
4000K CRI ≥ 90	1
2700K CRI ≥ 80	4
3000K CRI ≥ 80	5
3500K CRI ≥ 80	7
4000K CRI ≥ 80	6



CONTROL

DALI-2

LIGHT OPTIC

medium 28°	M
wide flood 67°	W

MATERIAL COLOUR



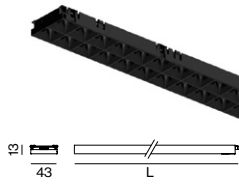

 traffic white RAL 9016	7
 jet black RAL 9005	8
 gold	9



SPOT LINE inset



SPOT LINE

SYSTEM POWER	COLOUR TEMP.	LUM. FLUX	L (mm)	ORDER CODE
18.4W	2700K	2460lm	1000	0 8 6 - 6 3 1 0 :: 3 
	3000K	2460lm		
	3500K	2630lm		
	4000K	2800lm		
26.7W	2700K	3700lm	1500	0 8 6 - 6 3 2 0 :: 3 
	3000K	3700lm		
	3500K	3950lm		
	4000K	4210lm		
34W	2700K	4930lm	2000	0 8 6 - 6 3 3 0 :: 3 
	3000K	4930lm		
	3500K	5270lm		
	4000K	5610lm		
41W	2700K	6160lm	2500	0 8 6 - 6 3 4 0 :: 3 
	3000K	6160lm		
	3500K	6580lm		
	4000K	7010lm		
47W	2700K	7390lm	3000	0 8 6 - 6 3 5 0 :: 3 
	3000K	7390lm		
	3500K	7900lm		
	4000K	8410lm		

Quickinfo

2700 K, 3000 K, 3500 K, 4000 K
 CRI \geq 80, CRI \geq 90, 3 SDCM
 up to 143 lm/W
 up to 2330 lm/m
 L90 @ 50000h
 DALI-2

Types

opal

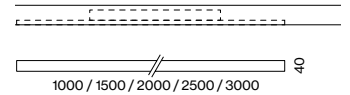

Colours



Light distribution



opal



reddot winner 2024



OPAL

linear inset

EN Linear light inset made of plastic; light inset, incl. high power adapter + converter can be installed flexibly and without tools; flush with profile system; equipped with specially computed lenses; homogeneously illuminated, satinised PMMA cover; energy-efficient LEDs with very good colour rendering; energy-efficient LEDs with very good colour rendering

DE Linear-Lichteinsatz aus Kunststoff; Lichteinsatz, inkl. High Power Adapter + Konverter, werkzeuglos einsetz- und verschiebbar; bündig im Profilsystem; bestückt mit speziell berechneten Linsen; homogen ausgeleuchtete, satinierte PMMA-Abdeckung; energieeffiziente LEDs mit sehr guter Farbwiedergabe; energieeffiziente LEDs mit sehr guter Farbwiedergabe

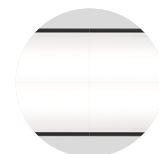

continuous
cover



up to 143 lm/W
(high efficiency)

Order options

COLOUR TEMPERATURE	
2700 K CRI ≥ 90	9
3000 K CRI ≥ 90	0
3500 K CRI ≥ 90	2
4000 K CRI ≥ 90	1
2700 K CRI ≥ 80	4
3000 K CRI ≥ 80	5
3500 K CRI ≥ 80	7
4000 K CRI ≥ 80	6

CONTROL

DALI-2

LIGHT OPTIC

opal

MATERIAL COLOUR

<input type="radio"/> traffic white RAL 9016	7
<input checked="" type="radio"/> jet black RAL 9005	8

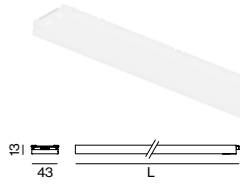
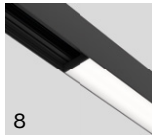

OPAL inset

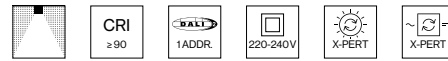

LIGHT INSET

SYSTEM POWER	COLOUR TEMP.	LUM. FLUX	L (mm)	ORDER CODE
18.2 W	2700 K	2050 lm	1000	0 8 6 - 6 1 1 0 :: 30
	3000 K	2330 lm		
26.4 W	2700 K	3070 lm	1500	0 8 6 - 6 1 2 0 :: 30
	3000 K	3490 lm		
33 W	2700 K	4090 lm	2000	0 8 6 - 6 1 3 0 :: 30
	3000 K	4660 lm		
41 W	2700 K	5110 lm	2500	0 8 6 - 6 1 4 0 :: 30
	3000 K	5820 lm		
46 W	2700 K	6140 lm	3000	0 8 6 - 6 1 5 0 :: 30
	3000 K	6980 lm		

Accessories

END CAPS

TYPE	ORDER CODE
end caps pair for opal	0 8 6 - 6 0 9 1 1 1

COVER

TYPE	L (mm)	ORDER CODE
continuous opal cover	6000	0 8 6 - 6 0 8 0 6 0 0 0
continuous opal cover	25000	0 8 6 - 6 0 8 2 5 0 0 0
opal cover	999	0 8 6 - 6 0 1 0 0 0 0 0
opal cover	1499	0 8 6 - 6 0 2 0 0 0 0 0
opal cover	1999	0 8 6 - 6 0 3 0 0 0 0 0
opal cover	2498	0 8 6 - 6 0 4 0 0 0 0 0
opal cover	2998	0 8 6 - 6 0 5 0 0 0 0 0

Quickinfo

2700 K, 3000 K, 3500 K, 4000 K
 CRI ≥ 80, CRI ≥ 90, 3 SDCM
 UGR ≤ 19 / 65° ≤ 1500 cd/m²
 up to 129 lm/W
 up to 1940 lm/m
 L90 @ 50 000 h
 DALI-2

Types

microprismatic

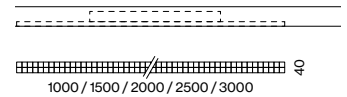

Colours



Light distribution



micropr.



reddot winner 2024



MICROPRISMATIC

linear inset

EN Linear light inset made of plastic; light inset, incl. high power adapter + converter can be installed flexibly and without tools; flush with profile system; completely homogeneously illuminated, microprismatic PMMA cover; for use in offices; energy-efficient LEDs with very good colour rendering

DE Linear-Lichteinsatz aus Kunststoff; Lichteinsatz, inkl. High Power Adapter + Konverter, werkzeuglos einsetz- und verschiebbar; bündig im Profilsystem; absolut homogen ausgeleuchtete, mikroprismatische PMMA-Abdeckung; für den Einsatz im Bürobereich; energieeffiziente LEDs mit sehr guter Farbwiedergabe

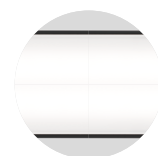

continuous cover



up to 127 lm/W (high efficiency)

Quickinfo

2700 K, 3000 K, 3500 K, 4000 K
 CRI ≥ 80, CRI ≥ 90, 3 SDCM
 UGR ≤ 19 / 65° ≤ 1500 cd/m²
 up to 129 lm/W
 up to 1940 lm/m
 L90 @ 50 000 h
 DALI-2

Types

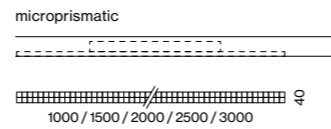

Colours



Light distribution



Order options

COLOUR TEMPERATURE

2700 K CRI ≥ 90	9
3000 K CRI ≥ 90	0
3500 K CRI ≥ 90	2
4000 K CRI ≥ 90	1
2700 K CRI ≥ 80	4
3000 K CRI ≥ 80	5
3500 K CRI ≥ 80	7
4000 K CRI ≥ 80	6

CONTROL

DALI-2

LIGHT OPTIC

microprismatic

MATERIAL COLOUR

- traffic white RAL 9016 7
- jet black RAL 9005 8

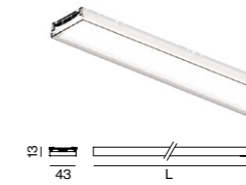
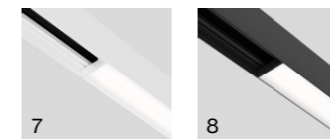

MICROPRISMATIC inset



LIGHT INSET UGR ≤ 22

SYSTEM POWER	COLOUR TEMP.	LUM. FLUX	L (mm)	ORDER CODE
18.2 W	3000 K	1710 lm	1000	0 8 6 - 6 1 1 0 :: 30
	4000 K	1940 lm		
26.4 W	3000 K	2560 lm	1500	0 8 6 - 6 1 2 0 :: 30
	4000 K	2910 lm		
33 W	3000 K	3420 lm	2000	0 8 6 - 6 1 3 0 :: 30
	4000 K	3890 lm		
41 W	3000 K	4270 lm	2500	0 8 6 - 6 1 4 0 :: 30
	4000 K	4860 lm		
46 W	3000 K	5120 lm	3000	0 8 6 - 6 1 5 0 :: 30
	4000 K	5830 lm		



LIGHT INSET UGR ≤ 19

SYSTEM POWER	COLOUR TEMP.	LUM. FLUX	L (mm)	ORDER CODE
8 W	3000 K	768 lm	1000	0 8 6 - 6 2 1 0 :: 30
	4000 K	873 lm		
11.6 W	3000 K	1150 lm	1500	0 8 6 - 6 2 2 0 :: 30
	4000 K	1310 lm		
14.7 W	3000 K	1540 lm	2000	0 8 6 - 6 2 3 0 :: 30
	4000 K	1750 lm		
17.9 W	3000 K	1920 lm	2500	0 8 6 - 6 2 4 0 :: 30
	4000 K	2180 lm		
20.3 W	3000 K	2300 lm	3000	0 8 6 - 6 2 5 0 :: 30
	4000 K	2620 lm		

Accessories

END CAPS

TYPE	ORDER CODE
end caps pair for microprismatic	0 8 6 - 6 0 9 1 1 1

COVER

TYPE	L (mm)	ORDER CODE
continuous microprismatic cover	6000	0 8 6 - 6 0 8 0 6 0 0 P
continuous microprismatic cover	25000	0 8 6 - 6 0 8 2 5 0 0 P
microprismatic cover	999	0 8 6 - 6 0 1 0 0 0 0 P
microprismatic cover	1499	0 8 6 - 6 0 2 0 0 0 0 P
microprismatic cover	1999	0 8 6 - 6 0 3 0 0 0 0 P
microprismatic cover	2498	0 8 6 - 6 0 4 0 0 0 0 P
microprismatic cover	2998	0 8 6 - 6 0 5 0 0 0 0 P



MICROPRISMATIC

linear inset

EN Linear light inset made of plastic; light inset, incl. high power adapter + converter can be installed flexibly and without tools; flush with profile system; completely homogeneously illuminated, microprismatic PMMA cover; for use in offices; energy-efficient LEDs with very good colour rendering

DE Linear-Lichteinsatz aus Kunststoff; Lichteinsatz, inkl. High Power Adapter + Konverter, werkzeuglos einsetz- und verschiebbar; bündig im Profilsystem; absolut homogen ausgeleuchtete, mikroprismatische PMMA-Abdeckung; für den Einsatz im Büroereich; energieeffiziente LEDs mit sehr guter Farbwiedergabe

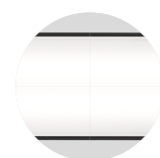

continuous cover



up to 127 lm/W (high efficiency)

LUMINOUS FLUX value calculated for CRI ≥ 80, CRI ≥ 90 -16%

Quickinfo

2700 K, 3000 K, 3500 K, 4000 K
 CRI ≥ 80, 3 SDCM
 up to 162 lm/W
 up to 3380 lm/m
 non DIM, DALI-2

Types

indirect

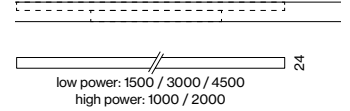
**Colour****Light distribution**

indirect



reddot winner 2024

**INDIRECT**

linear inset

EN Linear light inset made of plastic; light inset, incl. high power adapter + converter can be installed flexibly and without tools; flush with profile system; with indirect light component for additional accentuation of the ceiling; high quality lens system for maximum, homogeneous ceiling illumination; energy-efficient LEDs with very good colour rendering

DE Linear-Lichteinsatz aus Kunststoff; Lichteinsatz, inkl. High Power Adapter + Konverter, werkzeuglos einsetz- und verschiebbar; bündig im Profilsystem; mit indirekter Lichtkomponente für zusätzliche Akzentuierung der Decke; hochwertige Linsenoptik für maximale, homogene Deckenaufhellung; energieeffiziente LEDs mit sehr guter Farbwiedergabe

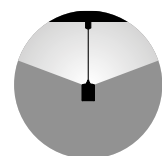

170° indirect
 illumination

Order options

COLOUR TEMPERATURE	
2700 K CRI ≥ 80	4
3000 K CRI ≥ 80	5
3500 K CRI ≥ 80	7
4000 K CRI ≥ 80	6

CONTROL
 DALI-2

LIGHT OPTIC
 batwing

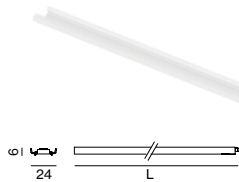

INDIRECT inset

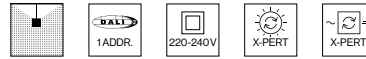

INDIRECT BATWING LOW POWER

SYSTEM POWER	COLOUR TEMP.	LUM. FLUX	L (mm)	ORDER CODE
17.7W	2700K	2240lm	1500	0 8 6 - 6 8 2 0 :: 30 B
	3000K	2240lm		
	3500K	2400lm		
	4000K	2550lm		
32W	2700K	4480lm	3000	0 8 6 - 6 8 5 0 :: 30 B
	3000K	4480lm		
	3500K	4790lm		
	4000K	5100lm		
47W	2700K	6720lm	4500	0 8 6 - 6 8 8 0 :: 30 B
	3000K	6720lm		
	3500K	7190lm		
	4000K	7650lm		

INDIRECT BATWING HIGH POWER

SYSTEM POWER	COLOUR TEMP.	LUM. FLUX	L (mm)	ORDER CODE
24.3W	2700K	2990lm	1000	0 8 6 - 6 8 1 5 :: 30 B
	3000K	2990lm		
	3500K	3190lm		
	4000K	3400lm		
43W	2700K	5980lm	2000	0 8 6 - 6 8 3 5 :: 30 B
	3000K	5980lm		
	3500K	6390lm		
	4000K	6800lm		

Accessories

MOUNTING ACCESSORIES



TYPE	ORDER CODE
drilling template for indirect inset	0 8 6 - 5 2 1 9 5 1 0

INDIRECT EXTENSION

SYSTEM POWER	COLOUR TEMP.	LUM. FLUX	L (mm)	ORDER CODE
2.6W low power	2700K	374lm	250	0 8 6 - 6 8 0 0 :: 30 B
	3000K	374lm		
	3500K	399lm		
5.4W high power	4000K	425lm	250	0 8 6 - 6 8 0 5 :: 30 B
	2700K	747lm		
	3000K	747lm		
	3500K	799lm		
	4000K	850lm		

max. inset length per driver: low power 4500mm, high power 2000mm
 without power supply

Example for extension

1500mm Scope of delivery low power PCBA

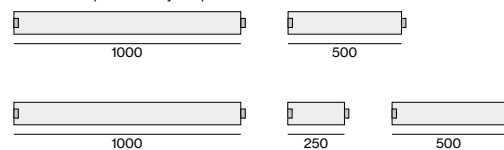

Extension by 250mm PCBA (new total length 1750mm)



reddot winner 2024



NOBA

decorative inset

EN Decorative pendant light inset made of aluminium; choice of single lamp, double lamps or triple lamp; light inset, incl. high power adapter + converter can be installed flexibly and without tools; surface polished chrome, brushed aluminium or powder coated; pendant fitting with suspension, incl. feed (black); can be individually shortened; high quality plano-convex glass lens; no multiple shadows; energy-efficient LEDs with very good colour rendering; ceiling mounting rings for multiple positioning of the luminaire in the room available as accessory

DE Dekorativer Pendelleuchten-Lichteinsatz aus Aluminium; wahlweise ein-, zwei- oder dreiflämmig; Lichteinsatz, inkl. High Power Adapter + Konverter, werkzeuglos einsetz- und verschiebbar; Oberfläche chrom poliert, Aluminium gebürstet oder pulverbeschichtet; abgependelt mit Pendelabhängung, inkl. Einspeiseleitung (schwarz); beliebig kürzbar; hochwertige plan-konvexe Glaslinse; keine Mehrfachschatten; energieeffiziente LEDs mit sehr guter Farbwiedergabe; Deckenmontageringe für multiple Positionierung der Leuchte im Raum als Zubehör erhältlich

Quickinfo

2700 K, 3000 K, 3500 K, 4000 K
 CRI ≥ 90, 2 SDCM
 up to 109 lm/W
 L80 @ 50 000 h
 DALI-2

Types

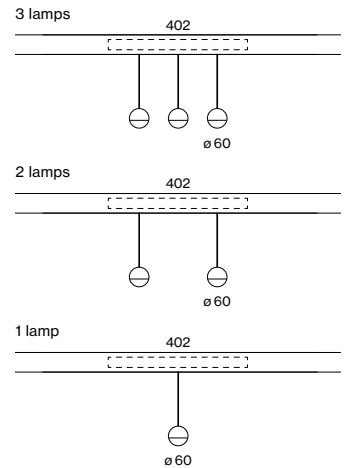

Colours



Light distribution



direct

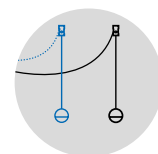

free positioning
by cable and hook



high quality
glass lens

Order options

MOUNTING

suspension 2000 mm

COLOUR TEMPERATURE

2700K	9
3000K	0
3500K	2
4000K	1

CONTROL

DALI-2

MATERIAL COLOUR

<input type="checkbox"/> traffic white RAL 9016	7
<input checked="" type="checkbox"/> jet black RAL 9005	8
<input type="checkbox"/> brushed aluminium	6
<input type="checkbox"/> chrome	4
<input type="checkbox"/> gun metal	5
<input type="checkbox"/> brushed brass	3
<input type="checkbox"/> rose gold	9

MATERIAL COLOUR

ACCESSORIES / DRIVER

<input type="checkbox"/> traffic white RAL 9016	7
<input checked="" type="checkbox"/> jet black RAL 9005	8

BEAM ANGLE

wide flood 67°

NOBA 60

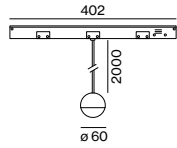

DOWNLIGHT 1 LAMP

INSET POWER	COLOUR TEMP.	LUMINOUS FLUX	ORDER CODE
10 W	2700 K	930 lm	086-711003
	3000 K	986 lm	086-711004
	3500 K	982 lm	086-711005
	4000 K	1040 lm	086-711006

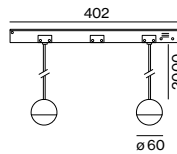

DOWNLIGHT 2 LAMPS

INSET POWER	COLOUR TEMP.	LUMINOUS FLUX	ORDER CODE
19.2 W	2700 K	1860 lm	086-711103
	3000 K	1970 lm	086-711104
	3500 K	1960 lm	086-711105
	4000 K	2090 lm	086-711106

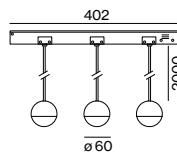

DOWNLIGHT 3 LAMPS

INSET POWER	COLOUR TEMP.	LUMINOUS FLUX	ORDER CODE
28.8 W	2700 K	2790 lm	086-712003
	3000 K	2960 lm	086-712004
	3500 K	2950 lm	086-712005
	4000 K	3130 lm	086-712006

Mounting accessories



HOOK ceiling mounted

TYPE	Ø-H (mm)	ORDER CODE
hook	16-30	030-100001



reddot winner 2024



ARY

decorative inset

EN Decorative pendant light inset made of aluminium; choice of single lamp, double lamps or triple lamp; light inset, incl. high power adapter + converter can be installed flexibly and without tools; surface powder coated; pendant fitting with suspension, incl. feed (black or white); can be individually shortened; good glare reduction due to recessed light point plane; incl. high quality lens system; precise radiation characteristics with different beam angles; shades available as accessory in RAL colours velvet beige, madeira brown, kingfisher grey, woodpecker olive, signal white or signal black; COB (Chip on Board) technology for maximum efficiency; no multiple shadows; energy-efficient LEDs with very good colour rendering; ceiling mounting rings for multiple positioning of the luminaire in the room available as accessory

DE Dekorativer Pendelleuchten-Lichteinsatz aus Aluminium; wahlweise ein-, zwei- oder dreiflammig; Lichteinsatz, inkl. High Power Adapter + Konverter, werkzeuglos einsetz- und verschiebbar; Oberfläche pulverbeschichtet; abgependelt mit Pendelabhängung, inkl. Einspeiseleitung (schwarz oder weiß); beliebig kürzbar; gute Entblendung durch zurückversetzte Lichtpunktebene; inkl. hochwertiger Linsenoptik; präzise Abstrahlcharakteristik mit verschiedenen Ausstrahlwinkeln; Shades in den RAL Farben velvet beige, madeira brown, kingfisher grey, woodpecker olive, signal white oder signal black als Zubehör erhältlich; mit COB (Chip on Board) Technologie für höchste Effizienz; keine Mehrfachschatten; energieeffiziente LEDs mit sehr guter Farbwiedergabe; Deckenmontageringe für multiple Positionierung der Leuchte im Raum als Zubehör erhältlich

Quickinfo

2700 K, 3000 K, 3500 K, 4000 K
CRI ≥ 90, 3 SDCM
up to 114 lm/W
L90 @ 50 000 h
non DIM, DALI-2

Types

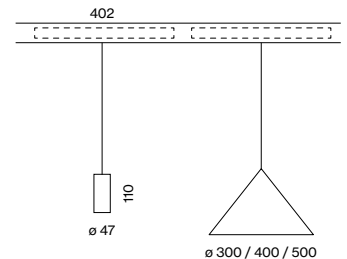

Colours



Light distributions

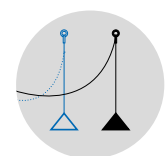

free positioning
by ring and hook

Order options

MOUNTING

suspension 2000 mm

COLOUR TEMPERATURE

2700K	9
3000K	0
3500K	2
4000K	1

CONTROL

DALI-2

MATERIAL COLOUR

<input type="radio"/> traffic white RAL 9016	7
<input checked="" type="radio"/> jet black RAL 9005	8
<input checked="" type="radio"/> special colours*	X

*cable and driver always in black

MATERIAL COLOUR ACCESSORIES / DRIVER

<input type="radio"/> traffic white RAL 9016	7
<input checked="" type="radio"/> jet black RAL 9005	8

BEAM ANGLE

medium 25°	M
flood 44°	F

SHADE COLOUR

<input type="checkbox"/> velvet beige RAL 085 8010	C
<input type="checkbox"/> madeira brown RAL 050 40 40	T
<input type="checkbox"/> kingfisher grey RAL 230 60 10	L
<input type="checkbox"/> woodpecker olive RAL 10 50 20	G
<input type="checkbox"/> signal white RAL 9003	W
<input type="checkbox"/> signal black RAL 9004	B

ARY

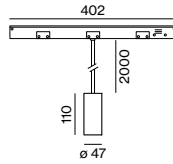
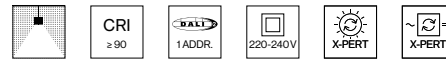

DOWNLIGHT 1 LAMP

INSET POWER	COLOUR TEMP.	LUMINOUS FLUX	ORDER CODE
14.1W	2700K	1390lm	086-7300::3■▲
	3000K	1450lm	
	3500K	1520lm	
	4000K	1560lm	

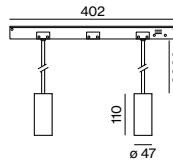

DOWNLIGHT 2 LAMPS

INSET POWER	COLOUR TEMP.	LUMINOUS FLUX	ORDER CODE
28.2W	2700K	2780lm	086-7310::3■▲
	3000K	2910lm	
	3500K	3040lm	
	4000K	3130lm	

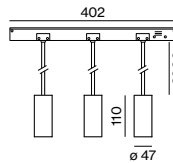
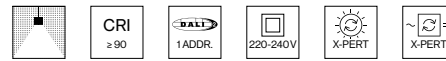

DOWNLIGHT 3 LAMPS

INSET POWER	COLOUR TEMP.	LUMINOUS FLUX	ORDER CODE
41W	2700K	4170lm	086-7320::3■▲
	3000K	4360lm	
	3500K	4560lm	
	4000K	4690lm	

Mounting accessories



TYPE	Ø-H (mm)	ORDER CODE
ring ceiling mounted	50-88	050-051021■
hook	18-58	050-051031■

Optical accessories

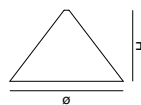

SHADE

TYPE	Ø-H (mm)	ORDER CODE
cone 300	300-188	049-593311□
cone 400	400-253	049-593411□
cone 500	500-318	049-593511□

only for one lamp

LUMINOUS FLUX value calculated for medium

Quickinfo

sensor
 ESSENTIAL, SENSE
 DALI-2

Type

sensor



41

Inset colours**Sensors**

essen-
 sense
 tial



reddot winner 2024

**SENSOR**

inset

^{EN} Sensor inset; choice of ESSENTIAL or SENSE; ESSENTIAL: brightness and presence sensor; SENSE: brightness, presence, temperature, humidity, air quality and noise level sensor; flush with profile system

^{DE} Sensor-Einsatz; wahlweise ESSENTIAL oder SENSE; ESSENTIAL: Helligkeits- und Anwesenheitssensor; SENSE: Helligkeits-, Anwesenheits-, Temperatur-, Luftfeuchtigkeits-, Luftqualitäts- und Lärmpegelsensor; bündig im Profilsystem

Order options

CONTROL

DALI-2

INSET COLOUR

- traffic white RAL 9016 7
- jet black RAL 9005 8

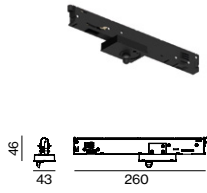

SENSOR inset



ESSENTIAL SENSOR

TYPE
brightness & presence

ORDER CODE
086-521811



SENSE SENSOR

TYPE
brightness, presence, temperature,
sound pressure, humidity, CO₂

ORDER CODE
086-521812