



## BO 55/70

track

**EN** Track light made of die-cast aluminium; surface powder coated; spotlight head 355° rotatable and 90° tiltable; converter integrated in the power track adapter; high-quality, aluminium, vapour deposition coated reflector with faceted design; precise radiation characteristics with different beam angles; good glare reduction due to recessed light point plane; optical attachments as accessories; COB (Chip on Board) technology for maximum efficiency; no multiple shadows; energy-efficient LEDs with very good colour rendering; adapter for toolless insertion or movement on a variety of 3-phase power tracks

**IT** Faretto da binario elettrificato in alluminio pressofuso; verniciatura a polvere; testata girevole 355° e orient. 90°; convertitore integrato nell'adattatore per binari elettrificati; riflettore d'alta qualità con ottica sfaccettata in alluminio applicato a vapore; curva fotometrica precisa con diversi angoli di emissione; ottima schermatura con superficie di emissione arretrata; unità ottiche come accessori; con tecnologia COB (Chip on Board) per la massima efficienza; assenza di ombre multiple; LED ad efficienza energetica con elevata resa cromatica; adattatore per installazione senza utensili o scorrimento in vari binari trifase

### Quickinfo

3000K, 3500K, 4000K  
CRI ≥ 90 2-SDCM  
up to 87lm/W  
L80 @ 50000h  
non DIM, DALI-2

### Types

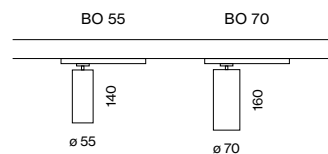

### Colours



### Light distributions

BO 55



spot med. flood

BO 70



spot med. flood wide flood



glare control via  
honeycomb louver



355° rotatable,  
90° tiltable

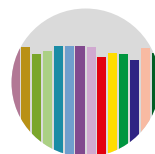

CRI ≥ 90,  
2 SDCM

## Order options

### COLOUR TEMPERATURE

3000K	5
3500K	7
4000K	6

### CONTROL

non DIM	1
DALI-2	3

### MATERIAL COLOUR

○ traffic white RAL 9016	7
● jet black RAL 9005	8

### BEAM ANGLE BO 55

spot 17°	S
medium 30°	M
flood 38°	F

### BEAM ANGLE BO 70

spot 15°	S
medium 23°	M
flood 37°	F
wide flood 57°	W

## Options on request

### COLOUR RENDERING INDEX

CRI ≥ 95, 2 SDCM

### CONTROL

Casambi

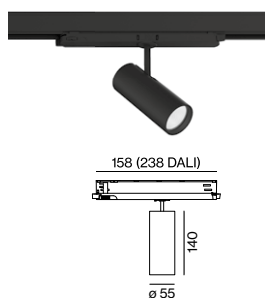

## BO 55 track



### TRACK LIGHT

<b>SYSTEM POWER</b>	<b>LUMINOUS FLUX</b>	<b>ORDER CODE</b>
24.8W	2150lm	180-7312



## BO 70 track



### TRACK LIGHT

<b>SYSTEM POWER</b>	<b>LUMINOUS FLUX</b>	<b>ORDER CODE</b>
40W	3410lm	180-7411

## Optical accessories

### HONEYCOMB LOUVER

TYPE	Ø-H (mm)	ORDER CODE
BO 55	50.3	007-1965598
BO 70	61.3	080-5900018

### OVAL LENS

TYPE	Ø-H (mm)	ORDER CODE
BO 55	50.3	007-1965890

### SOFT LENS

TYPE	Ø-H (mm)	ORDER CODE
BO 55	50.3	007-1965990

### WALLWASHER LENS

TYPE	Ø-H (mm)	ORDER CODE
BO 55	50.3	007-1965790



**Types**

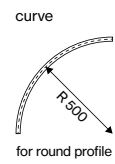
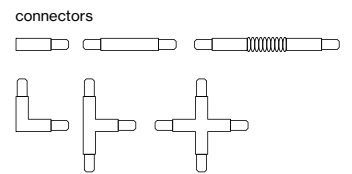
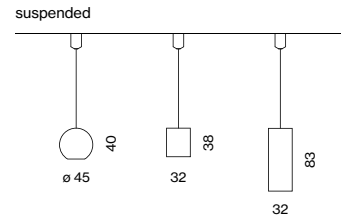
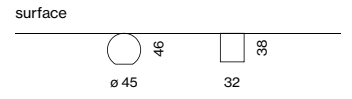
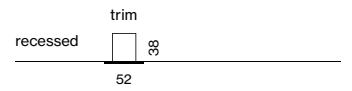

**Colours**



**TRACK 3-phase**

recessed/surface/suspended



curve connector



optimised adapter integration

# TRACK recessed

## Order options

### CONTROL

non DIM

DALI-2

### MATERIAL COLOUR

- pure white RAL 9010 7
- jet black RAL 9005 8

## Pole options

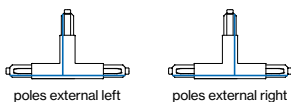
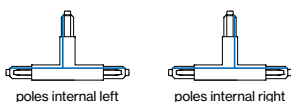

## TRACK 3-phase/3-phase + DALI-2-bus



### TRACK 240V-16A

L (mm)	ORDER CODE
2000	186-012213
3000	186-012313
4000	186-012413

end cap 186-022011

end feed left 186-022313  
 end feed right 186-022413  
 middle feed 186-021323

### CONNECTORS 240V-16A

**TYPE**      **ORDER CODE**  
 linear connector 186-021113

I-connector 186-022123

L-connector right 186-022133  
 L-connector left 186-022233

T-connector right (poles internal) 186-022143  
 T-connector left (poles internal) 186-022243  
 T-connector right (poles external) 186-022173  
 T-connector left (poles external) 186-022273

X-connector 186-022153

### MOUNTING ACCESSORIES

**TYPE**      **ORDER CODE**  
 clip 186-022511  
 cutting tool 186-021911

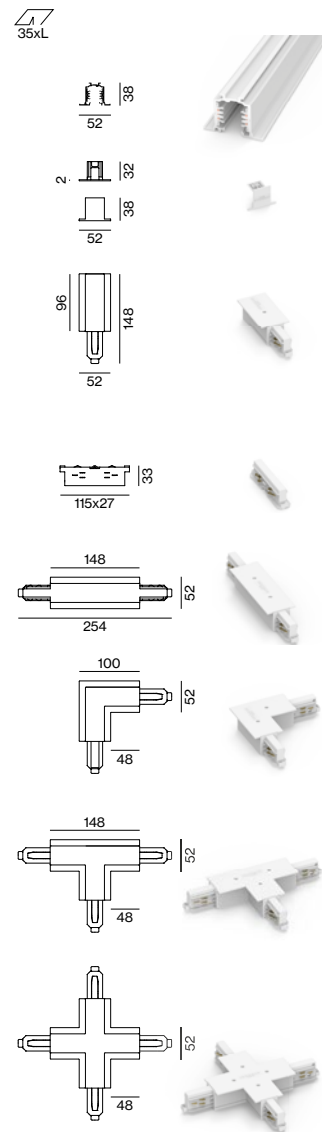

# TRACK

## surface/suspended

### Order options

#### CONTROL

non DIM  
 DALI-2

#### MATERIAL COLOUR

- pure white RAL 9010 7
- grey 6
- jet black RAL 9005 8

### Pole options

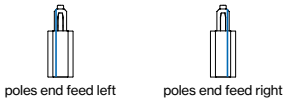
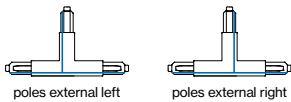
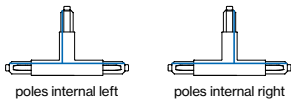

### TRACK 3-phase/3-phase + DALI-2-bus



#### TRACK 240V-16A

L (mm)	ORDER CODE
1000	186-011123
2000	186-011223
3000	186-011323
4000	186-011423

end cap 186-021011

end feed left 186-021313  
 end feed right 186-021413  
 middle feed\* 186-021323

\*only available in white and black

#### CONNECTORS 240V-16A

TYPE ORDER CODE  
 linear connector 186-021113

I-connector 186-021123

L-connector right 186-021133  
 L-connector left 186-021233

T-connector right (poles internal) 186-021143  
 T-connector left (poles internal) 186-021243  
 T-connector right (poles external) 186-021173  
 T-connector left (poles external) 186-021273

X-connector 186-021153

adjustable corner connector 186-021163

#### MOUNTING ACCESSORIES

TYPE ORDER CODE  
 ceiling clip 186-021511

pendant clip cable 186-021521  
 pendant clip rod 186-021541

joiner piece cable 186-021531  
 joiner piece rod 186-021551

cutting tool 186-0219110

#### SUSPENSION KIT

TYPE ORDER CODE  
 pendant 1000 186-021611

cable 1500 186-0217110  
 cable 3000 186-0217210  
 cable 5000 186-0217310

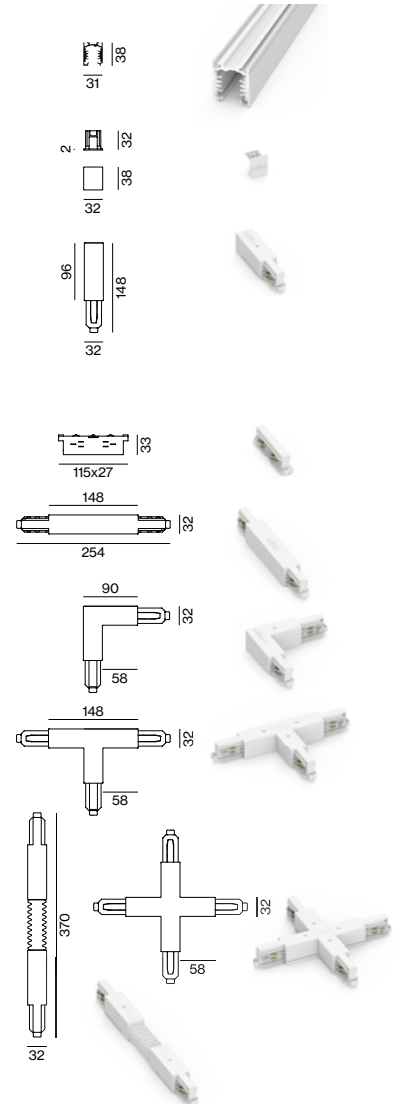

# TRACK high

## surface/suspended

### Order options

#### CONTROL

non DIM

DALI-2

#### MATERIAL COLOUR

○ pure white RAL 9010 7

● jet black RAL 9005 8

### Options on request

#### LIGHT OPTIC COVER

inset indirect

### Pole options

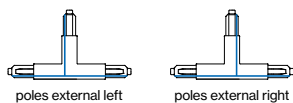
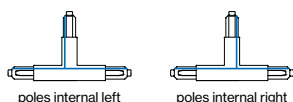

### TRACK high 3-phase/3-phase + DALI-2-bus



#### TRACK 240V-16A

L (mm)	ORDER CODE
1000	186-016113
2000	186-016213
3000	186-016313
4000	186-016413

end cap 186-026011

end feed left 186-026313

end feed right 186-026413

middle feed 186-021323

#### CONNECTORS 240V-16A

**TYPE**  
linear connector 186-026113

I-connector 186-026123

L-connector right 186-026133

L-connector left 186-026233

T-connector right (poles internal) 186-026143

T-connector left (poles internal) 186-026243

T-connector right (poles external) 186-026173

T-connector left (poles external) 186-026273

X-connector 186-026153

#### MOUNTING ACCESSORIES

**TYPE**  
pendant clip cable 186-0265210  
pendant sheet metal clip 186-0215220  
pendant clip rod 186-0265410

joiner piece cable 186-0265310

joiner piece rod 186-0265510

cutting tool 186-0219110

#### SUSPENSION KIT

**TYPE**  
pendant 1000 186-0216110

cable 1500 186-0217110

cable 3000 186-0217210

cable 5000 186-0217310

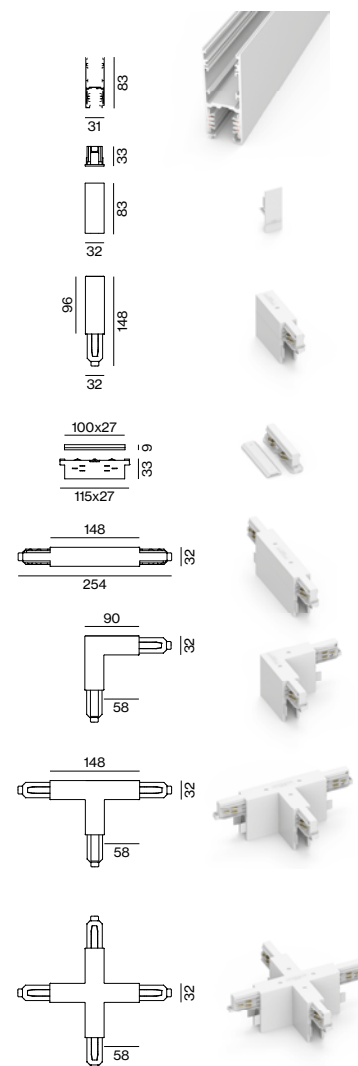

# TRACK round surface/suspended

## Order options

### CONTROL

non DIM  
DALI-2

### MATERIAL COLOUR

○ pure white RAL 9010 7  
● jet black RAL 9005 8

## Pole options

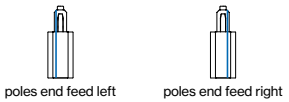
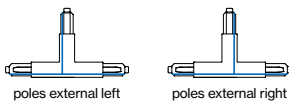
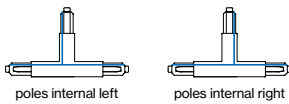

## TRACK round 3-phase/3-phase + DALI-2-bus



### TRACK 240V-16A

L (mm)	ORDER CODE
1000	186-015113
2000	186-015213
3000	186-015313
4000	186-015413



### TRACK CURVE 240V-16A

TYPE	ORDER CODE
R 500 90° left	186-015853
R 500 90° right	186-015863

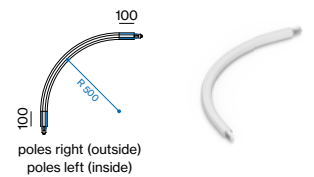

end cap 186-025011



end feed left 186-025313  
end feed right 186-025413  
middle feed 186-021323



### CONNECTORS 240V-16A

linear connector 186-021113



L-connector right (external) 186-025133  
L-connector left (internal) 186-025233

T-connector left (poles external) 186-025243  
T-connector right (poles external) 186-025143  
T-connector right (poles internal) 186-025273  
T-connector left (poles internal) 186-025173

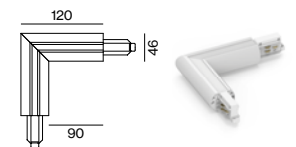

X-connector 186-025153

### MOUNTING ACCESSORIES

pendant clip cable 186-025521  
pendant clip rod 186-025541

joiner piece cable 186-025531  
joiner piece rod 186-025551

cutting tool 186-0279110

### SUSPENSION KIT

pendant 1000 186-021611

cable 1500 186-0217110  
cable 3000 186-0217210  
cable 5000 186-0217310