



BO 32 / 45 / 55

intrack

EN Track light made of die-cast aluminium; powder coated; spotlight head rotates 360° and tilts 90°; choice of single lamp, double lamps or triple lamp; converter in the adapter; with optional high quality lens system with precise radiation characteristic; or high quality, aluminium, vapour deposition coated reflector with faceted design; precise radiation characteristics with different beam angles; good glare reduction due to recessed light point plane; optical attachments as accessories; COB (Chip on Board) technology or high power LEDs - maximum efficiency; no multiple shadows; energy-eff. LEDs - very good colour rendering; adapter for toolless insertion or movement on a variety of 3-phase power tracks; adapter flush with the power track

ES Proyector de carril electrificado de fundición de aluminio inyectado; recubierto de polvo; cabezal de proyector giratorio de 360° y orientable 90°; disponible con flujo de luz simple, doble o triple; driver en el adaptador; opcionalmente con sistema óptico de lentes de alta calidad con precisa característica de emisión; o reflector de alta calidad vaporizado de aluminio con revestimiento de facetas esféricas; característica de emisión precisa con diferentes ángulos de emisión; buen control del deslumbramiento mediante plano de punto de luz retranqueado; los accesorios ópticos como accesorios; tecnología COB o LEDs de alta potencia - máxima eficiencia; no sombras múltiples; LED energét. efic. - excelente reprod. crom.; adaptador para instalación sin herramientas o desplazamiento en diferentes carriles electrificados de 3 fases; adaptador enrasado con la barra conductora

Quickinfo

2700 K, 3000 K, 3500 K, 4000 K
 CRI ≥ 90, 2 SDCM
 BO 32 up to 69lm/W
 BO 45 up to 91lm/W
 BO 55 up to 85lm/W
 L80 @ 50000h
 DALI-2

Types

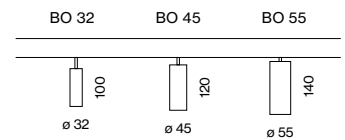

Colours



Light distributions

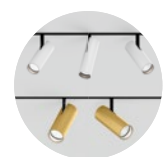
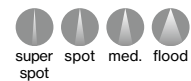

only one adapter with 2 or 3 lamps



360° rotatable
90° tiltable



glare control via
honeycomb louver

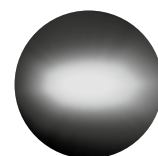

oval lens for oval
light illumination



CRI ≥ 95
2 SDCM

Order options

COLOUR TEMPERATURE	☐☐
2700K	4
3000K	5
3500K	7
4000K	6

CONTROL

DALI-2

MATERIAL COLOUR

☐ traffic white RAL 9016	7
● jet black RAL 9005	8
●●● special colours	X

BEAM ANGLE BO 32

spot 18°	S
medium 23°	M
flood 37°	F

BEAM ANGLE BO 45

super spot 8°	V
spot 14°	S
medium 24°	M
flood 39°	F

BEAM ANGLE BO 55

spot 17°	S
medium 31°	M
flood 37°	F

Options on request

COLOUR RENDERING INDEX

CRI ≥ 95, 2 SDCM

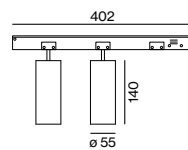
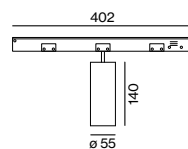
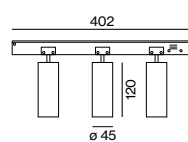
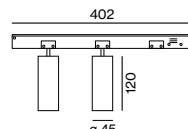
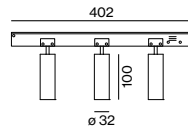
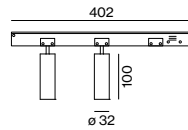

BO 32 intrack

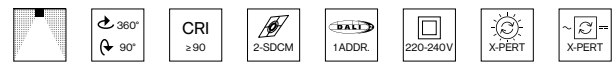

TRACK LIGHT

TYPE	SYS. POWER	LUMINOUS FLUX	ORDER CODE
2 lamps	20.5W	1440lm	180-7140::3☑▲
3 lamps	28.8W	2020lm	180-7150::3☑▲

BO 45 intrack



TRACK LIGHT

TYPE	SYS. POWER	LUMINOUS FLUX	ORDER CODE
2 lamps	14.2W*	super spot 2×320lm	180-7240::3☑V
	30W	spot 2×1020lm	180-7240::3☑S
	32W	med., flood 2×1330lm	180-7240::3☑▲
3 lamps	45W	spot 3×1020lm	180-7250::3☑S
	42W	med., flood 3×1180lm	180-7250::3☑▲

*do not use optical filters

BO 55 intrack

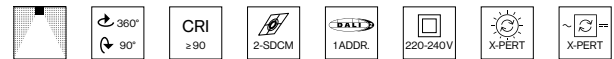

TRACK LIGHT

TYPE	SYS. POWER	LUMINOUS FLUX	ORDER CODE
1 lamp	24.8W	1940lm	180-7330::3☑▲
2 lamps	43W	3460lm	180-7340::3☑▲

Optical accessories

HONEYCOMB LOUVER

TYPE	Ø-H (mm)	ORDER CODE
BO 32	30·3	007-1965168
BO 45	42·3	007-1965188
BO 55	50·3	007-1965598

OVAL LENS

TYPE	Ø-H (mm)	ORDER CODE
BO 32	30·3	007-1965860
BO 45	42·3	007-1965880
BO 55	50·3	007-1965890

SOFT LENS

TYPE	Ø-H (mm)	ORDER CODE
BO 32	30·3	007-1965960
BO 45	42·3	007-1965980
BO 55	50·3	007-1965990

WALLWASHER LENS

TYPE	Ø-H (mm)	ORDER CODE
BO 32	30·3	007-1965760
BO 45	42·3	007-1965780
BO 55	50·3	007-1965790

LUMINOUS FLUX value calculated for
3000K, CRI ≥ 90, colour white, flood
2700K -5%, 3500K +0.5%, 4000K +7%



Types

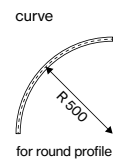
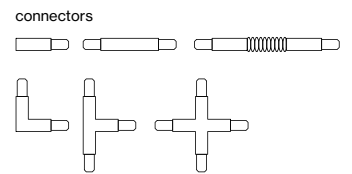
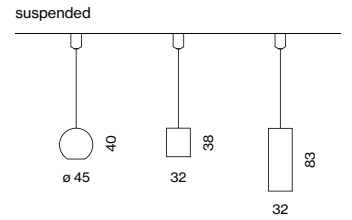
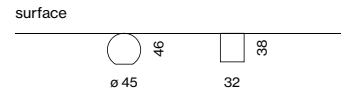
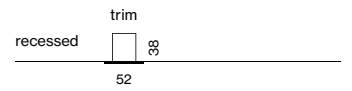

Colours



TRACK 3-phase
recessed/surface/suspended



curve connector



optimised adapter integration

TRACK recessed

Order options

CONTROL

non DIM

DALI-2

MATERIAL COLOUR

- pure white RAL 9010 7
- jet black RAL 9005 8

Pole options

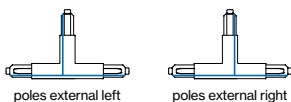
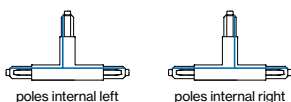

TRACK 3-phase/3-phase + DALI-2-bus



TRACK 240V-16A

L (mm)	ORDER CODE
2000	186-012213
3000	186-012313
4000	186-012413

end cap 186-022011

end feed left 186-022313
 end feed right 186-022413
 middle feed 186-021323

CONNECTORS 240V-16A

TYPE **ORDER CODE**
 linear connector 186-021113

I-connector 186-022123

L-connector right 186-022133
 L-connector left 186-022233

T-connector right (poles internal) 186-022143
 T-connector left (poles internal) 186-022243
 T-connector right (poles external) 186-022173
 T-connector left (poles external) 186-022273

X-connector 186-022153

MOUNTING ACCESSORIES

TYPE **ORDER CODE**
 clip 186-022511
 cutting tool 186-021911

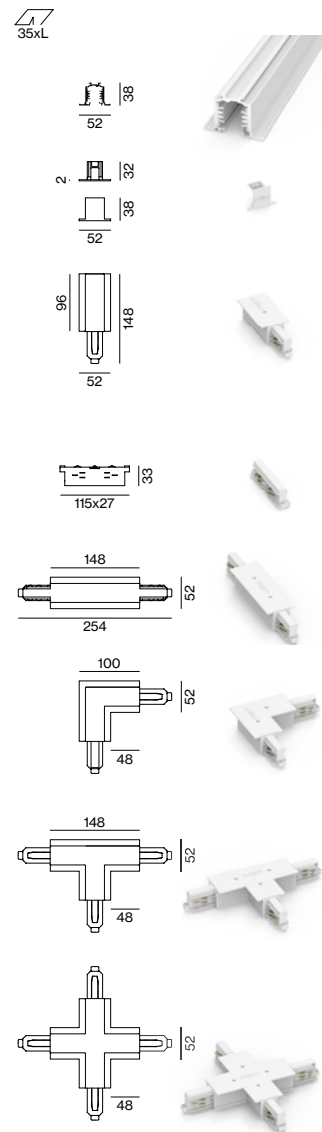

TRACK

surface/suspended

Order options

CONTROL

non DIM
 DALI-2

MATERIAL COLOUR

- pure white RAL 9010 7
- grey 6
- jet black RAL 9005 8

Pole options

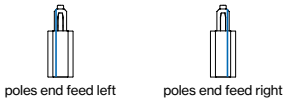
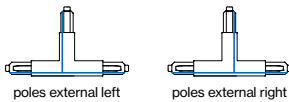
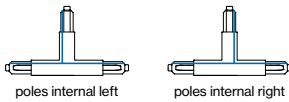

TRACK 3-phase/3-phase + DALI-2-bus



TRACK 240V-16A

L (mm)	ORDER CODE
1000	186-011123
2000	186-011223
3000	186-011323
4000	186-011423

end cap 186-021011

end feed left 186-021313
 end feed right 186-021413
 middle feed* 186-021323

*only available in white and black

CONNECTORS 240V-16A

TYPE ORDER CODE
 linear connector 186-021113

I-connector 186-021123

L-connector right 186-021133
 L-connector left 186-021233

T-connector right (poles internal) 186-021143
 T-connector left (poles internal) 186-021243
 T-connector right (poles external) 186-021173
 T-connector left (poles external) 186-021273

X-connector 186-021153

adjustable corner connector 186-021163

MOUNTING ACCESSORIES

TYPE ORDER CODE
 ceiling clip 186-021511

pendant clip cable 186-021521
 pendant clip rod 186-021541

joiner piece cable 186-021531
 joiner piece rod 186-021551

cutting tool 186-0219110

SUSPENSION KIT

TYPE ORDER CODE
 pendant 1000 186-021611

cable 1500 186-0217110
 cable 3000 186-0217210
 cable 5000 186-0217310

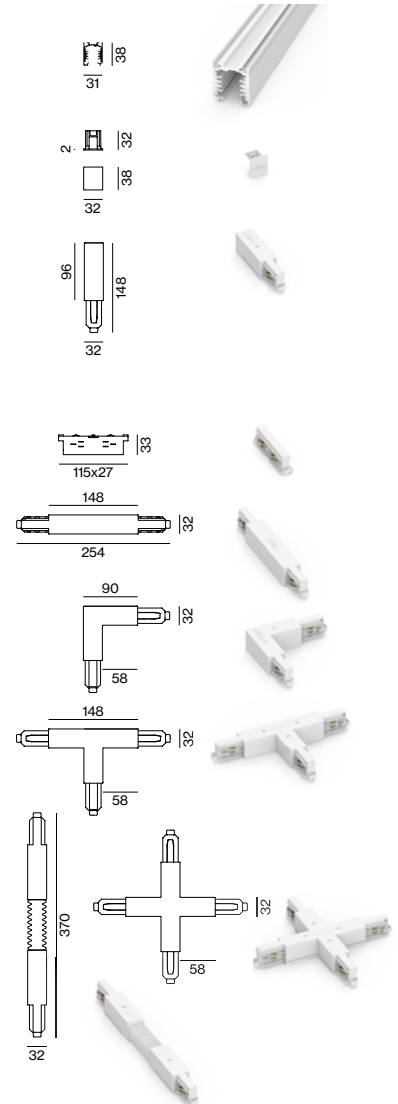

TRACK high

surface/suspended

Order options

CONTROL

non DIM

DALI-2

MATERIAL COLOUR

○ pure white RAL 9010 7

● jet black RAL 9005 8

Options on request

LIGHT OPTIC COVER

inset indirect

Pole options

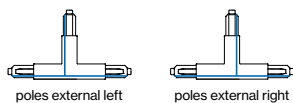
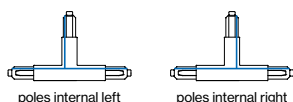

TRACK high 3-phase/3-phase + DALI-2-bus



TRACK 240V-16A

L (mm)	ORDER CODE
1000	186-016113
2000	186-016213
3000	186-016313
4000	186-016413

end cap 186-026011

end feed left 186-026313

end feed right 186-026413

middle feed 186-021323

CONNECTORS 240V-16A

TYPE
linear connector 186-026113

I-connector 186-026123

L-connector right 186-026133

L-connector left 186-026233

T-connector right (poles internal) 186-026143

T-connector left (poles internal) 186-026243

T-connector right (poles external) 186-026173

T-connector left (poles external) 186-026273

X-connector 186-026153

MOUNTING ACCESSORIES

TYPE
pendant clip cable 186-0265210
pendant sheet metal clip 186-0215220
pendant clip rod 186-0265410

joiner piece cable 186-0265310

joiner piece rod 186-0265510

cutting tool 186-0219110

SUSPENSION KIT

TYPE
pendant 1000 186-0216110

cable 1500 186-0217110

cable 3000 186-0217210

cable 5000 186-0217310

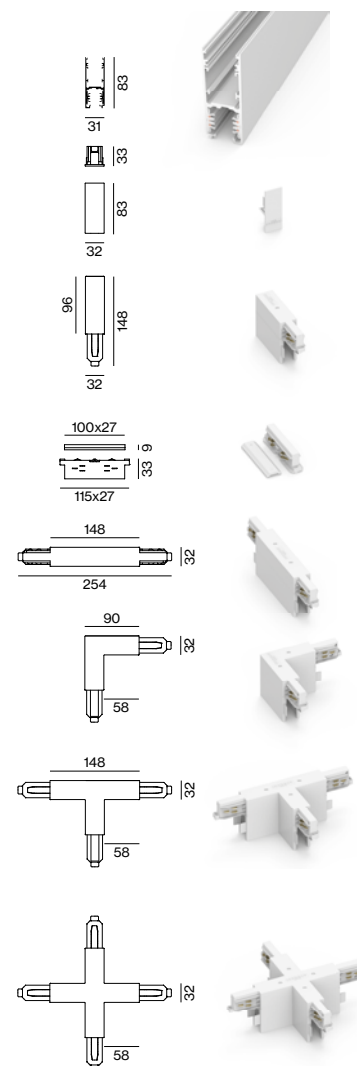

TRACK round surface/suspended

Order options

CONTROL

non DIM
DALI-2

MATERIAL COLOUR

○ pure white RAL 9010 7
● jet black RAL 9005 8

Pole options

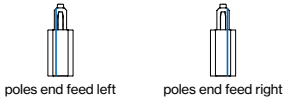
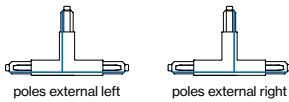
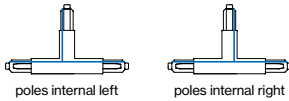

TRACK round 3-phase/3-phase + DALI-2-bus



TRACK 240V-16A

L (mm)	ORDER CODE
1000	186-015113
2000	186-015213
3000	186-015313
4000	186-015413



TRACK CURVE 240V-16A

TYPE	ORDER CODE
R 500 90° left	186-015853
R 500 90° right	186-015863

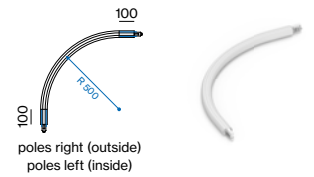

end cap 186-025011



end feed left 186-025313
end feed right 186-025413
middle feed 186-021323



CONNECTORS 240V-16A

linear connector 186-021113



L-connector right (external) 186-025133
L-connector left (internal) 186-025233

T-connector left (poles external) 186-025243
T-connector right (poles external) 186-025143
T-connector right (poles internal) 186-025273
T-connector left (poles internal) 186-025173

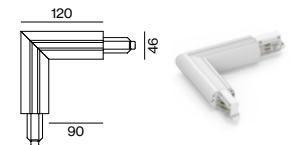

X-connector 186-025153

MOUNTING ACCESSORIES

pendant clip cable 186-025521
pendant clip rod 186-025541

joiner piece cable 186-025531
joiner piece rod 186-025551

cutting tool 186-0279110

SUSPENSION KIT

pendant 1000 186-021611

cable 1500 186-0217110
cable 3000 186-0217210
cable 5000 186-0217310